

A Roman roundhouse: archaeological excavation and monitoring on land at St Mary's Primary School, Docwra Road, Kelvedon, Essex, CO5 9DS

August 2016-July 2017



by Laura Pooley

with contributions by Stephen Benfield, Lisa Gray and Adam Wightman
figures by Mark Baister, Sarah Carter, Ben Holloway, Emma Holloway
and Laura Pooley

fieldwork by Ben Holloway, Sarah Carter, John Dodd, Robin Mathieson,
Callum Platts, Nigel Rayner, Alec Wade and Bethany Watson

**commissioned by Andrew Marchant, Ingleton Wood
on behalf of St Mary's Primary School**

NGR: TL 86446 18857 (centre)

Planning ref.: 16/00447/FUL

CAT project ref.: 16/07e

ECC code: KL39

Braintree Museum accession code: [tbc](#)

OASIS ref.: colchest3-256817



Colchester Archaeological Trust

Roman Circus House,
Roman Circus Walk,
Colchester,
Essex, CO2 7GZ

tel.: 01206 501785

email: lp@catuk.org

CAT Report 1007

October 2017

Contents

| | | |
|----|----------------------------------|----|
| 1 | Summary | 1 |
| 2 | Introduction | 1 |
| 3 | Archaeological background | 1 |
| 4 | Results | 2 |
| 5 | Finds | 7 |
| 6 | Environmental report | 6 |
| 7 | Discussion | 21 |
| 8 | Acknowledgements | 23 |
| 9 | References | 24 |
| 10 | Abbreviations and glossary | 25 |
| 11 | Contents of archive | 26 |
| 12 | Archive deposition | 26 |
| | Appendix 1 Context list | 28 |
| | Appendix 2 Bulk finds list | 32 |
| | Appendix 3 Animal bone list | 44 |
| | Appendix 4 Small finds list | 45 |
| | Appendix 5 Environmental results | 47 |

Figures after p47

OASIS summary sheet

List of photographs, tables and figures

Cover: general site shot

| | | |
|--------------|--|----|
| Photograph 1 | Roundhouse defined by drip-gully F21 and postholes, looking SE. | 3 |
| Photograph 2 | Well F19 with the roundhouse behind. The roundhouse entrance can be seen to the left of the well. Looking W. | 4 |
| Photograph 3 | Postholes F3, F4, F10, F13, F24 and F25, looking WNW | 5 |
| Photograph 4 | Strip of first monitoring area down to L5, looking NE | 6 |
| Photograph 5 | Excavation of pits in the second monitoring area, looking SW | 7 |
| Table 1 | Types and quantities of bulk finds | 7 |
| Table 2 | Pottery fabrics | 8 |
| Table 3 | Quantities of CBM by type | 12 |

| | |
|--------|--|
| Fig 1 | Site location |
| Fig 2 | Results of excavation and monitoring |
| Fig 3 | Phased results |
| Fig 4 | Close-up of roundhouse and post-structures |
| Fig 5 | Representative and feature sections |
| Fig 6 | Feature section |
| Fig 7 | Feature sections |
| Fig 8 | Roman barbotine pot (1) and fired clay (2-5) |
| Fig 9 | Fired clay (9-11) |
| Fig 10 | Site in relation to previous archaeological work (Rodwell 1988, Fig 40). |
| Fig 11 | 2016/7 results in relation to the 1971 excavations |
| Fig 12 | Comparison of 1971 and 2016/7 round structures. |

1 Summary

An archaeological excavation and monitoring was carried out at St Mary's Primary School, Docwra Road, Kelvedon in advance of the construction of a new classroom and playground. Located within the Roman settlement at Kelvedon, previous archaeological investigations on the development site had revealed a round Roman temple.

This current archaeological excavation revealed a Roman roundhouse consisting of nineteen postholes with an external drip-gully. The gully enclosed an area of approximately 12m in diameter with the roundhouse structure measuring 10m diameter. Dating evidence from the roundhouse would suggest that it fell out of use sometime in the mid to late 2nd century. Adjacent to, and probably contemporary with, the roundhouse was a deep well. Parallel lines of postholes nearby are probably fence-lines or fenced-enclosures, although there is a possibility that they may have formed a rectangular structure.

Subsequent monitoring revealed four short lengths of Roman ditch, one of which is curved and might possibly be part of drip-gully or wall-trench for another round structure, and several Roman pits.

Post-Roman features consisted of a medieval pit, a post-medieval pit/ditch and two postholes. Seven undated pits, five tree-throws and a natural feature were also recorded.

2 Introduction (Fig 1)

This is the archive report for an archaeological excavation and monitoring at St Mary's Primary School, Docwra Road, Kelvedon, Essex which was carried out between 18th-25th August 2016 and 14th June-19th July 2017. The work was commissioned by Andrew Marchant, Ingleton Wood, on behalf on the school in advance of the construction of a new classroom and playground. Work was undertaken by Colchester Archaeological Trust (CAT).

In response to consultation with Essex County Council Place Services (ECCPS), Historic Environment Advisor Teresa O'Connor advised that in order to establish the archaeological implications of this application, the applicant should be required to commission a scheme of archaeological investigation in accordance with the *National Planning Policy Framework* (DCLG 2012).

All archaeological work was carried out in accordance with a *Brief for archaeological excavation and monitoring*, detailing the required archaeological work, written by Teresa O'Connor (ECCPS 2016), and a Written Scheme of Investigation (WSI) prepared by CAT in response to the brief and agreed with ECCPS (CAT 2016).

In addition to the brief and WSI, all fieldwork and reporting was done in accordance with English Heritage's *Management of Research Projects in the Historic Environment (MoRPHE)* (English Heritage 2006), and with *Standards for field archaeology in the East of England* (EAA **14** and **24**). This report mirrors standards and practices contained in the Institute for Archaeologists' *Standard and guidance for archaeological excavation* (CIfA 2014a) and *Standard and guidance for the collection, documentation, conservation and research of archaeological materials* (CIfA 2014b).

3 Archaeological background

The following archaeological background utilises the Essex Historic Environment Record (EHER) held at Essex County Council, County Hall, Chelmsford.

The Historic Town Assessment Report for Kelvedon was prepared by Medlycott in 1999 and provides a full overview of the history of Kelvedon up to that date.

Settlement at Kelvedon originated in the Late Iron Age with timber structures and enclosures. It developed into a small Roman town situated to the south-east of the main London to Colchester Roman Road, focussed along a gravelled trackway or minor road deviating from the main Roman road, and dating from the mid-late 1st century (Rodwell 1988, 5, 54-55). Roman occupation began in the mid-late 1st century and peaked in the 2nd century when the settlement was enclosed by a defensive ditch. Excavations over the years have revealed a temple, possible *mansio*, industrial activity and four cemeteries outside the town enclosure (*ibid*). A mid-1st century Roman fort has also been postulated. By the end of the Roman period the town was in decline, although there is some evidence for continuation of settlement, not necessarily urban in nature, into the early Saxon period.

The proposed development site lies within the Roman town. Trenching in the area in 1968 revealed that Late Iron Age to early Roman buildings and structures surrounded the site and ran beneath the school building and playground areas (Rodwell 1988). One trench contained a gravel surface with a late 3rd century coin and pottery sherd with an applied bird. Another revealed a multi-phased site which included pits filled with domestic waste covered by the floor surface and hearth(s) of a large structure (EHER 14788).

Also located close to the development site was a small round building interpreted as a temple (Rodwell 1988; EHER 18766). Possibly originating in the Late Iron Age the temple was set within a gravelled *temenos* (temple precinct), into which pits containing votive objects had been cut. Building material for a second, more sophisticated structure, with a tessellated floor was also recovered, but no ground plan could be discerned. Both structures appear to have burnt down in the late second century and it is not known whether they were rebuilt (Medlycott, 1999).

4 Results (Figs 2-7)

Excavation

The excavation area was located within the footprint of the new classrooms and measured 26m by 18m (468m²). The site was stripped by a mechanical excavator under the supervision of a CAT archaeologist to the top of the archaeological horizon.

Four layers were identified. The modern tarmac surface with sub-base (L1-L2, c 0.44m thick) sealed a medium grey/brown silty modern accumulation horizon (L3, c 0.2m thick, probably associated with the previous use of the site as allotments). Layer L3 sealed natural sands and gravels (L4).

Roman

The majority of the features recorded during the excavation and monitoring dated to the Roman period.

The most significant feature on the site was a Roman roundhouse. This was formed by drip-gully F21, a U-shaped gully measuring 0.4-0.7m wide by 0.1-0.28m deep, enclosing an area of approximately 12m in diameter. A single c 3.3m wide entrance was located to the east-southeast. Internally, three postholes (F22, F23 and F47) were located on the edge of the gully either side of the entrance, with 13 postholes (F40-F43, F45, F46, F48, F51, F52, F57, F58, F59 and F60) irregularly-spaced around the circumference of the drip-gully, forming a roundhouse approximately 10m in diameter. Three other internal postholes (F26, F50 and F56) were out of alignment with the rest, but were presumably associated with the roundhouse structure. No trace of a central posthole was present. The postholes were on average 0.26m in diameter (ranging

from 0.1m to 0.38m in diameter) and were both U-shaped and V-shaped. They ranged in depth from 0.09m to 0.45m (averaging 0.19m), but five of the seven postholes over 0.2m in depth were located on the southeastern edge of the drip-gully where variations in stripping depth had resulted in ground level being c 0.1m higher. Two pits (F20 and F49) were also located either side of the entrance.

Finds from the drip-gully included a small amount of pottery, ceramic building material (mainly tessera cubes) and iron nail fragments with a larger quantity of structural fired clay (daub). Pottery dating indicates that the fill of the gully is no earlier than the mid to late 2nd century, suggesting that the roundhouse fell out of use by this date. A very small quantity of Roman finds was only recovered from two of the postholes (F22 and F42) and the two pits (F20 and F49).

To the northeast of the roundhouse, three postholes (F15-F17) appear to form a small structure of some kind (no trace of a fourth post-hole was evident). The postholes were both U- and V-shaped, and measured 0.3-0.34m in diameter and 0.13-0.16m deep.



Photograph 1 Roundhouse defined by drip-gully F21 and postholes, looking SE

To the east of the roundhouse was a large Roman feature (F19) measuring approximately 3m by 2.8m. It was excavated to a depth of 1.1m and augured for a further 1.2m (total depth of 2.3m) but not bottomed. The size, depth and straight-sides of this feature would suggest that it was a well, backfilled with a substantial quantity of Roman material. The lowest excavated fill contained dating evidence from the late 2nd/3rd to 4th century, suggesting that both the roundhouse and the well had fallen out of use at roughly the same time. Post-medieval and modern finds recovered from the mid and upper fills (with residual Roman material) show that the well had suffered a period(s) of sinkage/settling over this deep feature. The high instance of residual Roman material scattered among the post-medieval/modern finds suggests that the area had also been subjected to a degree of disturbance in this later period.

A large, shallow pit (F18) was located next to the well. It measured 2.2m by 1.4m by 0.2m deep and contained a very small quantity of Roman finds (three tessera cubes, one piece of brick/tile and one nail). This could conceivably be a later tree-throw or similar feature containing disturbed Roman material.



Photograph 2 Well F19 with the roundhouse behind. The roundhouse entrance can be seen to the left of the well. Looking W.

To the northeast of the roundhouse was a line of Roman postholes (F3, F4, F10, F13, F24 and F25). Aligned WNW to ESE the postholes were recorded for a distance of 10m with each spaced between 1.3-2.7m apart. They measured on average 0.52m in diameter (ranging from 0.4-0.7m in diameter) and 0.26m deep (0.21-0.32m), with both U- and V-shaped profiles present. All but one contained material of a 'Roman' date. Approximately 5.3m to the southwest was a second parallel line of undated postholes (F11, F12 and F14). Recorded for a distance of only 4m, these postholes measured on average 0.45m in diameter (ranging from 0.35-0.55m) by 0.32m deep (0.2-0.45m) and were also both U- and V-shaped. Three other undated postholes (F6, F7 and F27) located close-by may also be related. Probably forming fence-lines or fenced-enclosures associated with the roundhouse, the two sets of postholes could also conceivably form part of a rectangular structure measuring at least 10m long by 5.5m wide.

On the northern edge of the excavation area were two further Roman features – a possible pit or ditch terminal (F32) and a pit (F34). Undated postholes F8-F9 and F28-F30 were also recorded along this northern edge. Unfortunately, it was not possible to confirm if they were related to the Roman activity on this site, especially as two probable post-medieval/modern postholes (F33 and F35) were also identified close-by.



Photograph 3 Postholes F3, F4, F10, F13, F24 and F25, looking WNW

Post-Roman

Recorded on the northern edge of the excavation area was a single post-medieval (17th-18th century) pit or ditch terminal F31 and two probable post-medieval/modern postholes (F33 and F35).

Natural/Tree-throws

Natural feature F38 and tree-throws F2, F5, F37, F44 and F53 were also recorded.

Monitoring of new hard play areas

Two separate areas were stripped by the contractor under archaeological supervision to formation level.

The first monitoring area was located to the southeast of the excavation and measured approximately 634m². Modern topsoil (L6, c 0.3m thick) sealed a layer of modern dump containing pottery and glass (L5), probably associated with allotments that existed here before the school was built. Excavations did not go below L5.



Photograph 4 Strip of first monitoring area down to L5, looking NE

The second monitoring area was located immediately to the northwest of the excavation area. It was stripped to formation level in two sections measuring 30m by 10m and 20m by 3m (totalling 360m²). Four layers were identified (L1-L4) as per the excavation (see above). Where significant archaeological horizons were revealed these were excavated and recorded by hand (see results below), but large areas were not stripped below L3.

Roman

The majority of the dated features recorded during monitoring were Roman. Four Roman pits were present along the northwestern edge of the monitoring area, with two small sections of ditch identified between these and the excavation area.

Ditch F66 was aligned WNW/ESE and measured 0.5m wide by 0.19m deep. However, the ditch was not identified during monitoring further to the WNW or within the excavation area to the ESE.

Part of a curved ditch (F63) was also revealed during monitoring measuring 0.4m wide by 0.19m deep. This is potentially significant as it could be a small section of ring-gully representing a second roundhouse on the development site. Unfortunately though, the majority of the feature was not revealed during monitoring as stripping in this area did not exceed below L3, so this identification must remain extremely tentative. Although, if assumed to be a ring-gully, the projected edges of the feature would enclose an area approximately 6m in diameter which is small for a roundhouse.

Two further ditches (F61 and F62) could not be dated but are presumed to be Roman. Unfortunately, these ditches could not be traced during subsequent monitoring to the northwest, suggesting that they might have terminated, been removed by later pits or were aligned largely along the gap in the monitoring areas.

Post-Roman

A single sherd of medieval (c 12-14th century) pottery (plus two sherds of residual Roman pottery) was recovered from pit F68.

Undated features

Seven undated pits (F64, F65, F71, F72, F74, F75 and F76) were recorded.



Photograph 5 Excavation of pits in the second monitoring area, looking SW

5 Finds

by Stephen Benfield (unless otherwise stated)

5.1 Introduction

A significant quantity of finds was recovered, of which most are Roman, consisting mostly of pottery, tile and brick (including tesserae), and fired clay. There are two prehistoric flints (broadly dated as Neolithic-Bronze Age) and a small number of post-Roman (medieval, post-medieval and modern) finds. A moderate quantity of animal bone was also recovered, mostly associated with contexts containing finds of post-medieval date, indicating the acidic nature of the soils. The quantities of each finds type are listed in Table 1. The finds are listed by context and finds number in the finds appendix (Appendix 2), with the animal bone (Appendix 3) and small finds (Appendix 4) listed separately.

| Finds type | No. | Wt/g. |
|---------------------------------|------------|--------------|
| Pottery | 233 | 3099 |
| Ceramic building material (CBM) | 489 | 21424 |
| Fired clay | 324 | 13026 |
| Animal bone | 93 | 1408 |
| Flint (worked flint) | 2 | 14 |
| Quernstone (lava) | 2 | 72 |
| Glass | 2 | 10 |

| Finds type | No. | Wt/g. |
|-------------------|-----|-------|
| Clay tobacco pipe | 2 | 4 |
| Nails (iron) | 35 | - |
| Shell (oyster) | 9 | 206 |
| Burnt stone | 13 | 329 |
| Slag | 4 | 199 |
| Coke/cinder | 4 | 19 |
| Charcoal | 2 | - |

Table 1 Types and quantities of bulk finds

5.2 Pottery

In total 233 sherds of pottery were recovered (weighing 3099g). The great majority of this is Roman with a few grog-tempered sherds of Late Iron Age-type and a few sherds that are post-medieval or modern. The Roman pottery was recorded using the Chelmsford fabric series (Going 1987), commonly used for recording pottery in Essex. The Roman pottery forms were recorded using the Chelmsford form series (Going 1987) and the Colchester *Camulodunum* (Cam) form series (Hull, 1958). The post-Roman pottery was recorded using the Essex fabric series (Cunningham 1985 & CAR 7). The fabrics and the quantity of pottery for each fabric type are listed in Table 2.

| Fabric code | Fabric name | No. | Wt/g | EVE |
|--------------------|--|-----|------|------|
| Roman: | | | | |
| 1 | Colchester colour-coat | 9 | 140 | 0.06 |
| 2 | Nene Valley colour-coat | 2 | 36 | 0.07 |
| 4 | Hadham oxidised red wares | 5 | 24 | |
| 21 | Miscellaneous oxidised red wares | 4 | 48 | |
| 27 | Colchester buff ware | 2 | 120 | |
| 31 | Unspecified buff wares | 2 | 8 | |
| 39 | Fine grey wares | 2 | 16 | |
| 40 | Black-burnished 1 | 4 | 30 | 0.03 |
| 41 | Black-burnished 2 | 11 | 105 | 0.27 |
| 44 | Storage jar fabrics | 16 | 544 | 0.23 |
| 45 | Romanising grey wares | 5 | 36 | |
| 47 | Sandy grey wares (general) | 115 | 1146 | 1.33 |
| 47s | Sandy coarseware (unsourced) | 2 | 28 | |
| 48 | Rettendon-type ware | 2 | 8 | |
| 55 | South Spanish amphora | 3 | 245 | |
| 58 | Amphora (uncertain type/origin) | 2 | 152 | 0.18 |
| SASG | South Gaulish samian | 2 | 10 | |
| SACG | Central Gaulish samian | 3 | 10 | 0.02 |
| BSW | Black surfaces wares | 31 | 289 | 0.48 |
| GROG | Grog-tempered ware (Belgic-type) | 3 | 26 | |
| USCC | Unspecified colour-coat wares | 1 | 2 | |
| | <i>Total</i> | 226 | 3023 | 2.67 |
| Post-Roman: | | | | |
| 20 | Medieval sandy greywares (general) | 1 | 4 | |
| 21 | Sandy orange wares | 1 | 14 | |
| 40 | Post-medieval (glazed) red earthenware | 2 | 10 | |
| 40B | Stock-type black glazed ware | 1 | 2 | |
| 45G | English stoneware | 1 | 26 | |
| 48D | Staffordshire-type white earthenwares | 1 | 20 | 0.08 |
| | <i>Total</i> | 7 | 76 | 0.08 |

Table 2 Pottery fabrics

Late Iron Age and Roman

In total the Late Iron Age (LIA) and Roman pottery assemblage consists of 226 sherds weighing 3023g with an EVE of 2.67. The great majority of this comes from two features – well F19 which produced 103 sherds weighing 1347g (EVE 1.17) (a few sherds of post-medieval pottery were also recovered from the upper fill) and the drip-gully F21 which produced 31 sherds weighing 525g (EVE p.24).

A few grog-tempered sherds (Fabric GROG) are of LIA-type, broadly dating to the period of the late 1st century BC to the mid 1st century AD. These are residual in the upper fill of pits F19 and F34. The remainder of the assemblage is of certain post-conquest (Roman period) date. Recognisable imports are very limited. There are three sherds of samian, two from South Gaul (mid to late 1st century) and one Central Gaulish (2nd century). Also a few amphora sherds in Spanish fabric (Fabric 55) almost certainly from form Dressel 20, broadly current in the mid 1st to the early 3rd century and two other that are probably from (unidentified) amphorae (Fabric 58). Overall, finewares (including samian) make up about 10% of the assemblage both by sherd count (number) and weight. These consist of a small number of colour-coat and slipped sherds from several regionally important potteries – Colchester (Fabric 1), Nene Valley (Fabric 2) and Hadham (Fabric 4) – together with a few sherds that are unsourced (Fabric USCC). The finewares also include sherds from a panel-dot beaker of form H5/H6 (Cam 122/123) dating to the late 1st to 2nd century and sherds from an unusual, highly decorated vessel of 2nd century date recovered from the annular gully F21 (see below). The panel dot beaker is in a fabric fine sandy, reminiscent of Hadham or possibly West Stow, although this form is not associated with the kilns at West Stow, the one published example from there probably being a Wattisfield product (West 1990, fig 79 no 207). Together the fineware pottery forms and fabrics broadly span the period of the late 1st/2nd to 4th century.

The coarsewares include black-burnished wares, both southwestern BB1 (Fabric 40) and probably Colchester produced BB2 (Fabric 41). Examples of bowl forms B1 (Cam 39B), B2.11 (Cam 38B) and B4 (Cam 37B) are recorded in BB2 and jar form G9 with acute lattice decoration (Cam 279A) in BB1. Most of the coarseware pottery is unsourced although this is almost certainly of regional and local production. The largest fabric groups represented are sandy greywares (Fabric 47), black surface wares (BSW) and heavily-tempered sherds from storage jars (Fabric 44). The greywares include sherds from a range of jars – forms G5, G9.1/9.2 (?Cam 278), including a large storage-type jar G44 (Cam 273-type), and dishes/bowls forms B1 (Cam 39B) and B6 (Cam 305B). Although sherds from bowls are also present in black surface wares, the only closely-identified form is the neckless jar G24 (dated 2nd-4th century). Two greyware sherds with flint inclusions are possibly Rettendon-type ware (Fabric 48).

It can be noted that a group of pottery kilns has been located in Kelvedon (Rodwell 1988, Area J) but are dated to the early Roman period and primarily associated with fabrics that include grog-temper and are not likely to be a significant source of the pottery recovered from the site (*ibid* 25-26 & 114). However, a local kiln of late Roman date is known nearby at Inworth, northeast of the Roman settlement (Going 1987, 78-89). This produced vessels in sandy greywares (Fabric 47) including a range of jar, dish and bowl forms of the same general late Roman form-types as recovered from the excavation, and a small part of the pottery associated with the kiln is also in flint-tempered fabric (Fabric 48).

Pottery from well F19

Well F19 is a large deep feature, hand excavated to a depth of 1.1m it was found to be in excess of 2.3m deep by hand auguring. In total 104 pottery sherds weighing 1353g (EVE1.17) were recovered from the fill. This is just over 60% of the pottery recovered from the site both by count (sherd number) and weight. The lower part of the excavated fill (lower fill) produced a moderate quantity of pottery consisting of 17 sherds weighing 152g (finds no. 22). This included a small sherd (6g) of oxidised Hadham ware (Fabric 4) dated to the late 3rd to 4th century, while another sherd (8g), a sandy redware (Fabric 21), is possibly also a late Roman Hadham product. The only other closely-datable sherd is a rim from a dish of form B2.11 (Cam 38B) of 2nd/late 2nd to 3rd century date. Pottery attributed to the mid-fill consists of 28 sherds weighing 418g (finds nos 21 and 25). The latest-dated Roman pottery among this consists of sherds from bowls of form B6 (Cam 305B) dated late 3rd to 4th century, as well as a greyware

sherd with flint inclusions (48) probably of early to mid 4th century date. The majority of the pottery is associated with the upper fill with a total of 59 sherds weighing 733g (finds no. 20). This contained early residual material (Fabric GROG) while the latest closely-dated Roman pottery is a sherd from a Nene Valley flanged bowl of form B6 (Cam 305) which is broadly late 3rd to 4th/4th century.

Interestingly, there were a few sherds of post-medieval pottery, CBM, clay pipe and glass from the mid to upper excavated fills. Settlement and sinkage over such a large, deep feature, could permit material to accumulate in the upper parts long after the feature had gone out of use, so that the well itself and its lower fills (mostly unexcavated) date to earlier than that indicated by the pottery recovered.

Overall it would appear that the lower excavated fill of well F19 dates to at least the late 3rd or 4th century. The absence from the well of any specifically very late Roman pottery, for example late shell-tempered ware (Going 1987 Fabric 51), could indicate that the latest fill predates the mid-late 4th century; although it should be noted that no pottery that could be closely-dated to the latest Roman period (late 4th to early 5th century) was recovered from the site generally. It is likely that the earlier, unexcavated fills, of the well would be of earlier Roman date but this cannot be confirmed.

Pottery from drip-gully F21

Drip-gully F21 produced a total of 31 sherds weighing 525g (EVE p.24) The more closely-datable sherds indicate that the fill is no earlier than the mid to late 2nd century. The pottery comes from four excavated sections (sx) of the gully (see Fig 2 for locations), sx3-sx4 being the largest in terms of excavated length. The surviving gully itself was relatively shallow at between 0.1-0.28m in depth. Only small quantities of pottery were recovered from each of the excavated sections: sx1 8 sherds weighing 63g, sx2 4 sherds weighing 192g, sx3 7 sherds weighing 132g and sx4 12 sherds weighing 138g.

The majority of the pottery from the drip-gully consists of greyware sherds (Fabric 47) which are not closely-dated other than as Roman (mid/late 1st to 4th century). The more closely-datable of the coarsewares consist of sherds from beaker and jar forms and all come from sx1. Part of the body of a panel-dot beaker of form H5/H6 (Cam 122/123) in a distinctive fine-sand fabric (Fabric 47s) can be dated to the late 1st to 2nd century. A jar rim suggests it comes from a BB-type jar, probably form G9.1/G9.2 (? Cam 278) and can be dated to the early/mid 2nd to 3rd century. There is also a sherd from a folded beaker in greyware which is likely to date no earlier than the early/mid 2nd century. With this are sherds from two colour-coated fineware pots. One (sx1) is represented by a single sherd with a pale grey fabric, orange margins and brownish surface coat. The source of this sherd is not clear and is recorded as an unsourced colour-coat (USCC). The other, from sx3, consists of sherds from an unusual, highly decorated beaker and is discussed below.

The pottery from the drip-gully (F21) and from the lower fill of the deep well (F19) could indicate that they fell out of use at or about the same time, in or after the mid to late 2nd century.

A large beaker with unusual barbotine decoration (Fig 8.1)

Seven sherds (weight 132g) from a barbotine decorated beaker (find no. 34) were recovered from sx3 of drip-gully F21. The sherds are in a grey fabric with a darker grey surface slip/coat and come from a large pot, the girth diameter of which appears to be around 0.22m. The surface of one sherd (with part of a human figure) appears slightly darker in tone and the human figure is out of scale to animals depicted on other sherds. However, it seems likely that all these pieces probably belong to one pot, especially given the size and the unusual nature of the decoration that make it a rare and unusual vessel. One group of sherds (of which three join) have parts of a scene of running animals (moving right to left) among vines. A stag can be clearly identified and the

vines can be identified by a triangular bunch of (ripe) grapes and vine leaves on plant tendrils. There is also the lower part of the trunk of a vine in a negative image where the barbotine has fallen away. One sherd (not joining) has an out-stretched human right arm which is clothed with a garment sleeve reaching to the elbow and holding upright a thin staff or wand (possibly a spear – although this seems less likely) tipped with a small trefoil head. It is notable that the human figure is not in proportion with the animals, seen on the other sherds, being much larger in relative scale. The sherd with this figure retains a small part of the base of the rim showing it comes from a large, cornice rim beaker.

The nature of the decoration can be closely compared with decorative schemes seen on a few vessels from Colchester recovered during the excavation of Roman kilns on the west side of the town in the 1950's. One of these, a bowl in a similar sounding 'hard, dark grey ware', has a frieze of animals, including a stag, progressing right to left amid vines with grape bunches (Hull 1963, fig 53 no. 9). Another, in a more typical Colchester colour-coated ware fabric, has human figures among vines with grape bunches, including one with a radiate head dress (possibly part of a mask) and holding onto vine stems or vine stem pieces (*ibid* fig 53 no. 13). A vine and grape bunch also appear on another sherd in local (Colchester) colour-coated ware (*ibid* fig 54 no.3 & p 93). Although the fabric of the pot here is not typical of much of the Colchester colour-coated ware production, the close comparisons with vessels from the kilns at Colchester indicate that this is probably a Colchester product (Fabric 1), while the cornice rim indicates a 2nd-century, Hadrianic-Antonine, date.

There is no doubt but that this is and would have been an unusual and special pot. The images could indicate a familiarity with vines and grapes in Britain and more specifically in this area. Viniculture in the province remains slightly contentious, although proposed for a number of sites such as Wollaston in Northamptonshire, and the middle Nene Valley in general has been suggested as an area with extensive viniculture/wine production (Brown et al 2001). However, similar scenes with vines and animals are also depicted on Colchester samian (Hull 1963, fig 29, no. 2) and derive from a more general stock of samian motifs used on decorated pots in the northwestern provinces. Nonetheless, on the more elaborate and rare barbotine decorated pots associated with Colchester the additional depiction of unusually attired figures, possibly involving masks, that are active within the scene suggests a representation of either real, probably local events, or active local mythologies (*ibid*, fig 53, no. 13). The presence of the figure on the pot here sets it apart from the usual repertoire of barbotine work that commonly feature animals associated with the hunt and decorative scrolls. The association of vines might suggest Bacchus while the staff or wand could represent a Thyrsus and gods are depicted on some barbotine pots from the Nene Valley and other potteries in Britain (Webster 1991, 140-157). This seems unlikely as none of the figures on the more unusual Colchester barbotine pots equate with typical depictions of gods (apart from the hooded spirits of the Cucullati figures) and the figure on the pot here has a garment that extends as a sleeve to below the elbow which would be unusual for Bacchus. Rather the vessel motifs suggest it could reference a countryside celebration or festival with religious overtones of the natural cycle and rebirth; perhaps serving to underline that aspects of religion, ritual and superstition were probably close and constant companions in everyday life. It can be noted that this is not the only unusual figure decorated pot to have been found at Kelvedon as part of an unusual Late Iron Age bowl with relief-stamped figures was recovered from the fill of a well within the settlement dated to the pre-Flavian period (Rodwell 1988, 107-110).

Medieval, post-medieval and modern

Only a few sherds of pottery of post-Roman date were recovered. There are one, possibly two, sherds of medieval pottery. One (Fabric 20) comes from pit F68 and can be broadly dated to the period of the late 12th/13th to 14th century. The other comes from the upper fill of well F19. This is an oxidised sherd that is probably medieval (Fabric 21) but might be post-medieval. Sherds of post-medieval pottery (Fabrics 40,

40B and 45), broadly of 16th/17th to 18th century date, come from the upper fill of well F19 and from pit/ditch F31. A single sherd of modern factory pottery (Fabric 48D) was recovered from L3.

5.3 Ceramic building material CBM

The ceramic building material (CBM) recovered is overwhelmingly of Roman date. This consists of Roman brick and tile totalling 114 pieces, together weighing 14977g, and a large number of floor tesserae amounting to 356 individual tessera cubes (combined weight 6073g). A small quantity of pieces of medieval/post-medieval peg-tiles and brick are also present. The CBM is listed and quantified by type in Table 3.

| CBM code | Name | No. | Wt/g |
|--------------------|---------------------|-----|------|
| <i>Roman:</i> | | | |
| RT | Roman tegula | 15 | 2317 |
| RI | Roman imbrex | 33 | 4093 |
| RB | Roman brick | 17 | 4770 |
| RBT | Roman brick or tile | 49 | 3797 |
| Tess | Roman tessera | 356 | 6073 |
| <i>Post-Roman:</i> | | | |
| BR | Brick | 2 | 16 |
| PT | Peg-tile | 17 | 358 |

Table 3 Quantities of CBM by type

Roman CBM

The Roman CBM includes pieces from roof tiles (*tegula* and *imbrex*), Roman brick and tesserae. The fabric of these is typically orange/reddish-orange with a relatively fine fabric body containing fine-medium sand, while some pieces, where abraded, are slightly silty. Although a few pieces contain larger amounts of medium sand, only a few pieces were visually distinct. All of these are *imbrex* tile which had been fired a grey colour on surfaces and have a fabric which contains some pieces of calcified flint. One comes from F42 (35) with three other pieces from F19 (21). These pieces might represent just one tile and the fabric may simply be overfired making flint inclusions more prominent as they have been calcified white, occasional small flint being less noticeable among the other CBM. Overall, the impression of the Roman CBM is of relatively clean or moderately well refined clays being used in production.

Of the 114 pieces of Roman brick and tile recovered most of this, a total of 98 pieces weighing 12445g, comes from the fill of well F19 associated with Roman pottery, the latest of which is dated to the late 3rd-4th century. The broken nature of the tile and brick leaves little that can be directly reported in terms of the various types other than the descriptions in the finds appendix, although the absence of pieces from flue tiles is of note. Several large pieces of *imbrex* tile were recovered from the lower excavated fill of well F19 (22), suggesting they might not have a long depositional history before arriving in that context. In terms of individual tiles there are three pieces from *tegula* lower cut-aways (LCA). These were recovered from F19 and two can be broadly identified to types. One (F19 (21)) is of Warry Type C5 or D15 (Warry 2006, fig 1.3) and the other is probably part of the same LCA form. These are of possible mid-late Roman date as Warry suggests a date range of mid 2nd to mid 3rd century for C Types and mid 3rd+ dating for D Types. Pieces of bricks from F19 (22) probably represent either *pedalis* or *Lydion* tiles. One of these appears to have been affected by heat and two *tegula* from the same feature (finds no. 21) also appear to be burnt, hinting at the possible use of tile pieces in hearths or ovens.

A significant number of flooring tesserae were recovered. Almost all of these come from two features – well F19 which produced a total of 285 tesserae (4845g) and drip-gully F21 which produced a total of 60 tesserae (1058g). Tesserae were recovered throughout the excavated fill of F19 with 39 coming from the lower fill and 83 from the mid fill and the remainder (163) from the upper fill. Other features (F18, F20, F42, F44 and F49) produced only one or a few tesserae, all together totalling a further nine. The

tesserae themselves can be divided in four ways – tesserae not made from orange/red tile, tesserae that are a roughly square-cube shape, broadly rectangular shaped tesserae and tesserae which have evidence of setting in a floor. Only three tesserae are in other fabrics, all are buff-coloured, one from F19 (21) appears to be made from cream/buff coloured tile, another from F42 (35) appears to be a piece from a Dressel 20 amphora. While not an exact division, it was noted that many of the tesserae approximate to cubes are roughly 20mm-25mm square while others are thinner, commonly made from tiles approximately 13mm-15mm thick. Two of the thinner pieces, from F19 (20) are clearly made from *imbrex* tile and this is probably the significant difference between the two broad shape groups. The thickness of the square cubes suggests that many of these may be made from *tegula* bases (rather than generally thicker Roman brick) and include one from F21 (34) that is clearly made from a *tegula* flange while another, from F21 (11) has part of a tile signature. Both broad shape groups are represented among the tesserae from both F19 and F21. That many of the tesserae had been set in a mortar floor can be seen from the traces of white mortar adhering to one end and around the sides.

No mortar base as might be expected from a broken-up floor was found associated with the tesserae or the features from which they were recovered, so that they had probably been stripped from a floor(s) located elsewhere in the Roman settlement. A number of the tesserae are clearly broken and this probably happened during stripping of a floor surface. Also, the different thickness of tesserae might indicate that they derive from more than one floor or different areas of flooring. That there had possibly been a dump or stock of these in this area is suggested by their presence in a number of features and the quantity recovered from F19 and F21.

5.4 Fired clay

Pieces of fired clay were recovered from a number of features. In several instances this is just one or a few pieces (F19, F22 and F42) while small groups of between 10-30 pieces were recovered from F16, F17 and F32. The largest assemblage from any one feature comes from the fill of the drip-gully F21, which produced 324 pieces together weighing just over 13kg (13026g) (see below). Apart from one piece with inclusions/temper consisting of coarse vegetable matter, from F19 (20), the fabric of all of the fired clay is sandy. Some inclusion of vegetable matter are common, usually showing as traces of stem-like pieces on surfaces and which are possibly responsible for moderately common small voids in the clay body. Some pieces from F17 (7) and F22 (13) were noted as containing coarse white quartz sand.

Fired clay from drip-gully F21

Drip-gully F21 produced a significant assemblage of structural fired clay. The latest closely-dated pottery from the fill indicates this was deposited in or after the mid to late 2nd century. While excavated sections are of different lengths and the gully is deeper in some sections than others, it is clear that the fired clay was not evenly distributed around the gully. However, at a broad level, the variations in the quantity of fired clay recovered reflect the different size (length) of the individual excavated sections and the different surviving depth of the gully in each section (sx1-4). Only a single piece (14g) was recovered from sx1, sx2 produced 52 pieces at 810g, sx3 238 pieces at 11072g and sx4 33 pieces at 1130g.

The fired clay is quite broken-up and is lightly abraded resulting in rounded edges. Much is essentially nondescript apart from flat surfaces that are readily apparent on many pieces. In general, apart from two pieces with grey, vitrified surfaces, all of the fired clay from the gully is visually quite similar. Surfaces (even internal surfaces in wattle voids) are generally oxidised, orange-red (occasionally buff), and the fabric core is generally grey/grey-brown (but also occasionally buff). The fired clay is moderately hard, but easily marked with a fingernail. The fabric is sandy with occasional small stones and tending to surface powder when rubbed. Striations on the surface and some voids in the fabric indicate the presence of some organic material.

Description of fired clay from F21

Sixty-four of the larger pieces from F21 s3 with surfaces and/or wattle voids were examined. This was chosen as the fired clay from this section contained the largest number of diagnostic pieces; although like the other fired clay from the drip-gully it is quite broken-up. The longest dimension of any of these pieces is 130mm, but is commonly between 50-80mm. Broad smooth parts of wattle voids are relatively common. These mostly survive as semi-circular grooves, one edge running parallel to the surfaces of the piece. These indicate round wattle sticks generally about 25-35mm in diameter, although some are larger at up to c 40mm. None are complete circular voids. Pieces from corners and edge pieces (with two flat surfaces at right angles) indicate that at least some come from woven panels. A few pieces preserve impressions from square-cut timbers, one apparently a rail or post around which the wattles have been woven.

The more diagnostic pieces appear to broadly divide into two groups:

One group consists of a number of pieces that retain parts of two adjacent wattle voids. In several of the pieces these are separated by a ridge of clay about 10-20mm thick. On these pieces the clay has split longitudinally along the wattle construction and only one surface is present. The surviving clay and the position of the wattles indicate a wall originally c 80-90mm thick. On most of these pieces it can be clearly seen that the wattles have been woven as each void is at a different angle to the other.

Another larger group consists of pieces with an inner and outer surface and a thickness of about 35-40mm leaving little depth of clay cover over the wattles. The wattles are generally spaced at about 25mm and it is noted that a number of pieces have just a single wattle impression surviving in one of the broken ends. The absence of complete (round) wattle voids suggests the clay has broken around the thin apex where the wattle is close to a surface and several pieces suggest that not all of the wattles would have been completely encased in clay. This effect is seen on one piece where a wattle was against an internal, square cut, timber rail. The covering of clay over the rail to the original surface is about 37mm thick, about the same as the thickness of all of the pieces in this group. This suggests that many of these pieces might have come from areas between internal, flat timber bars or posts and the wall surfaces.

The most obvious source of the fired clay is from the wall of the roundhouse. Comparisons of walling material from roundhouses are limited, but the material can be viewed in relation to structural finds and the interpretation of Middle Iron Age roundhouses at Little Waltham, Essex (Drury 1978). Several of the roundhouse structures there are conjectured as having a polygonal wall plan consisting of post and panel construction (*ibid*, 121). Fired clay from the site of Little Waltham roundhouse C6 (considered to be of irregular polygon design) indicated that it came from wall panels c 100mm thick (*ibid*, 114). The fired clay (burnt daub) associated with roundhouse C6 was mostly recovered from the fill of two ditches cut through it that defined a later enclosure (255 & 256). In the area of the roundhouse these ditches contained 'much burnt daub and vitrified daub' (*ibid*, 18) considered to have derived from the building that had been burnt down. Another Little Waltham roundhouse, C11, also produced a quantity of fired clay/daub, this time coming from the ring-gully, primarily from the south terminal (*ibid*, 16). This included 'much burnt daub and vitrified daub' with sharp (fresh) breaks and also burnt wood consistent with a rapid deposition following the fire.

While the broken-up nature of the fired clay here makes interpretation difficult, in comparison with Little Waltham the more diagnostic of the material shows both similarities and differences. As well as pieces that indicate a thickness comparable with wall daub from Little Waltham, many pieces (with two surfaces) are rather thin and more on the scale of an internal partition wall as seen in a Roman building at Chelmsford (Drury 1988, fig 59 no. 24). However, one or two thin pieces retain impressions from parts of internal squared-timber bars or posts (with right-angle edges) within the wall, showing wattles passing between them and the outer wall surface. These pieces clearly represent only part of the wall thickness. That other of the thinner pieces could also have come from covering on timber is suggested by a different appearance of the two surfaces on some of them, although surface abrasion makes this difficult to be sure. Whether this would allow all of the fired clay to be part of the same wall structure is not entirely clear as it remains difficult to account for thin pieces

that clearly come from the corner of a frame/panel. However, the fired clay certainly suggests a structure with wattles woven between square rails or posts and with squared-timber at the edges and corners.

In relation to the two pieces of vitrified clay, vitrified clay daub was also present among the fired clay debris from the roundhouses at Little Waltham. While a very different context, this phenomenon has not been noted among the burnt Boudican destruction material at Colchester, which could suggest that pieces from hearths or ovens were also associated with roundhouse debris rather than coming entirely from burnt walls; although at Must Farm, Cambridgeshire, the heat in a burning roundhouse had been sufficiently intense to vitrify food scraps. The pieces of fired clay at Kelvedon are also slightly rounded from abrasion, unlike the rapidly deposited Iron Age wall daub from Little Waltham roundhouse C11, and do not appear to have been immediately deposited after being fired/burnt. A lack of burnt wood also suggests that this is the case and again contrasts with the material from the gully of roundhouse C11. The fired clay from this area of the site is closely associated with the ring gully and is almost certainly associated with the roundhouse, although in the absence of burnt wood it does not appear to represent primary deposited fire debris. The possibility that it could also have been deposited from elsewhere is raised by the presence of quantities of tile tesserae cubes (probably stripped from a floor elsewhere in the settlement) that had been deposited/dumped in the roundhouse gully, although this possibility seems unlikely. However, it can be noted that the site of a building defined by a similar penannular gully has previously been excavated close-by (Rodwell 1988, 55). A layer of burnt structural daub covered the internal gravel floor and the building was considered to have been burnt down in the late 2nd century; broadly the same date as suggested by the pottery for the finds in the gully of the building here.

Fig 8.2 F21 Sx3 (34) corner piece with two adjacent flat surfaces and part of wattle void.

Fig 8.3 F21 Sx3 (34) piece with flat surface and two close set differently angled (woven) wattle voids

Fig 8.4 F21 Sx3 (34) piece with flat surface and thick clay covering over wattle

Fig 8.5 F21 Sx3 (34) piece with two opposed flat surfaces and wattle void in edge, clay thickness c 38mm

Fig 9.6 F21 Sx3 (34) piece with two opposed flat surfaces and clear wattle void in one edge and small part of groove from second wattle void in other edge, clay thickness c 36mm

Fig 9.7 F21 Sx3 (34) piece with two opposed flat surfaces and clear wattle void in each edge, diameter of one void, exceeding clay thickness, possibly resulting from resting against an internal bar/rail

Fig 9.8 F21 Sx3 (34) piece with flat surface and impression of square cut timber on reverse with part wattle void between the timber rail and the surviving surface

Fig 9.9 F21 Sx3 (34) piece with flat surface and impression of square cut timber on reverse and parts of two wattle voids between the timber and the surviving surface, showing wattle pressed up against the timber

Fig 9.10 F21 Sx3 (34) piece with impression from corner of square cut timber

Fig 9.11 F21 Sx3 (34) right-angle corner piece from square framing, clay thickness c 35mm

5.5 Animal bone (Appendix 3) by Adam Wightman

Introduction

In total, there are ninety-three fragments of animal bone with a combined weight of 1.408kg. The bone was hand collected from a small Roman pit (F67), a small medieval/post-medieval pit (F73), and from the upper fills of a large, deep Roman well (F19). The majority of the bone recovered from F19 was from the mid/upper fills, which also contained post-medieval pottery, glass, clay-pipes and peg-tile fragments (finds numbers 20, 21 and 25). A small quantity of bone was recovered from the lower fill (find number 22), which only contained Roman material. The overall level of bone preservation was good to moderate.

Methodology

All of the bone was examined to determine range of species and elements present. Species identifications were made using the author's modern comparative collections. All identifiable elements were recorded. However, certain elements were not identified to exact taxon but rather to the level of unidentified small, medium or large taxon. These comprise carpals, tarsals (apart from the astragalus and calcaneus), cranial fragments (except for the zygomatic and occipital), ribs and cervical, thoracic and lumbar vertebrae. Fragments of unidentified large taxa derive primarily from cattle (*Bos sp.*), although may also include horse (*Equus sp.*) and larger deer species. Fragments recorded as medium-sized taxon will predominantly be from sheep (*Ovis sp.*) and pig (*Sus sp.*), although goats (*Capra sp.*), dog (*Canis familiaris*) and smaller deer species (*Cervus sp.*) may also be represented. If it was not possible to determine the element from which a fragment originated it was noted whether the fragment was from the appendicular skeleton (limbs) or the axial skeleton (vertebrae, ribs, etc, including cranial skeleton).

Each bone was inspected to determine if bone-, horn- or antler-working was present in the assemblage. Evidence of butchering and any indications of skinning, horn-working and other modifications were recorded. When available, the fusion state of identifiable bones was also recorded and ages were assessed following Silver (1969). A record was made of any other relevant information such as pathologies. Counts and weights were taken and recorded for each context. The side of the body from which the bones were derived was also noted. Measurements were not taken for the bones as there would have been too little data for any meaningful interpretation. Bones of sheep and goats were recorded as *Ovis* (sheep species) based on the greater frequency of this species in these climes, but diagnostic metapodials, horn cores and deciduous fourth premolars (DPM4) were distinguished between the two species following the criteria of Boessneck (1969). The completeness and parts represented for each specimen were noted using Serjeantson's (1996) eight-zone method of recording (Z1-Z8 in Table 1). Only fragments that accounted for at least 50% of a single zone were recorded. In this instance, the zone was not noted for elements that are not identified to exact taxon (i.e. ribs, vertebrae etc.). Recently broken bones were joined where possible and have been counted as single fragments.

The analysis was carried out following a modified version of guidelines by English Heritage (Davis, 1992) and also with reference to Cohen & Serjeantson 1996; Hillson 1986 and Payne 1987. A catalogue of the faunal remains is included in the site archive.

The assemblage

Most of the bone is relatively solid in structure with little erosion to the cortical surface of the bone. However, some of the bone has a slightly 'chalky' structure, probably resulting from the post-depositional deterioration of the bone caused by acidity in the soil. The animal bone assemblages are samples collected from pits which were 50% excavated. A digital copy of the tabulated data from the analysis of the animal bone assemblage can be found in the site archive.

A butchered cattle scapula, which had been sawn and possibly chopped, was recovered from Roman pit F67. Four bones were recovered from the medieval/post-medieval pit F73; a cattle molar and mandible fragment; a probable piece of vertebrae and a small fragment of long bone recovered from a soil sample (find number 48).

The other eighty-eight bones were recovered from the fills of the well F19. Eighty-one of those are from the mid/upper fills which are likely to have settled into the pit in the post-Roman period. Bones from cattle (scapula, metatarsal, horncore, humerus), horse (1st phalanx), pig (mandible, ulna), sheep (mandible, humerus) and bird (humerus, radius, ulna, sternum) were identified, with cattle being the most common species present. Only three bones from the lower fill were ascribable to taxon and these were all cattle. Interestingly, all of these elements are scapula fragments, an element which

is also common in the bone assemblage from the mid/upper fills of the pit. The majority of the bones which were not ascribable to exact taxon are from large mammals (of which the largest proportion is likely to be from cattle). The same is true for the unidentified fragments of axial and appendicular bone.

Evidence of butchery was exhibited on cattle and large mammal bones from F19. Cut marks and chop marks were observed on ribs, vertebrae and scapula fragments. The proximal end of a scapula had been sawn off and there was evidence of sawing on a horncore, which may indicate that horn-working was taking place at the site. There is also evidence that some cattle bones were broken while fresh, presumably to extract marrow.

Discussion

The animal bone assemblage from F19 is of a notable size, especially considering the low quantity of bone recovered from other contexts excavated at the site. This could be because the bone assemblage from the fill of this pit is post-medieval in date rather than Roman. It is possible that bone has not survived in many of the Roman contexts because the ground is too acidic for their survival, whereas the post-medieval bone has not been subjected to these conditions for as long. It is likely that the majority of the bone assemblage is derived from food waste from a property in the close vicinity, probably sometime during the post-medieval period.

5.6 Other finds

Worked flints

by Adam Wightman

Only four struck flints were recovered and are described below. One, from L5, might be Early Neolithic in date, but both are only really broadly datable as later prehistoric (Neolithic-Bronze Age) and both are residual in the contexts from which they came.

L5 (41) End scraper, made on the distal end of either a snapped blade or a broken flake. The broken edge has been abruptly retouched to form the scraping edge. In terms of date it could be Early Neolithic, but a broad dating as later prehistoric is more certain and more appropriate.

F73 (45) Probable core fragment or broken core rejuvenation flake, not closely dated other than as later prehistoric.

Quernstone: Two pieces of broken and abraded imported (German) lava quernstone (weighing 12g and 60g) from the upper fill F19 (20 & 22). The likelihood is that they are residual Roman finds.

Glass: Two pieces of dark green glass, probably bottle glass of post-medieval/modern date came from well F19. One is from the upper fill (26) the other is attributed to the mid fill (21).

Clay tobacco pipe: Two small stem pieces come from well F19, both with a stem bore c 1-1.5mm and both probably 19th century. One from the upper fill (20) and one attributed to the mid fill that was recovered from processing a bulk sample (25).

Nails: A total of 39 iron (fe) nails and nail pieces, or pieces that are almost certainly part of nails, were recovered. Almost all of these come from contexts dated to the Roman period and the great majority are, or are likely to be, of Roman date. The majority come from features associated with the roundhouse: five nails from the gully (F21), one (broken) from a posthole (F22) and 22 nails/nail pieces from well F19. In F19 a total of 9 of the nails/nail pieces come from the upper fill (20) with eight from the mid fill (21) and three from the lower fill (22). All of the nails that could be measured are between c 40-90mm in length, although all of the shorted nails, at between 45-55mm, come from

a group of nails in the upper fill of F19 (20). Where there is sufficient of the nail for identification, all could be classified as Manning Type 1b (nails below 150mm in length, usually with flat round heads) (Manning 1986, 134).

Shell: The only shell recovered is a small group of oyster shells (9 pieces weighing 206g) consisting of eight mostly complete (half) shells from the upper fill of F19.

Burnt stones: A small number of stones (13 in total) were recovered that had been altered by exposure to heat (burnt) or were discoloured so as to suggest exposure to moderate heat. Almost all are flints. The majority were recovered as as single, or just a couple of stones/pieces from contexts dated as Roman including a posthole inside the roundhouse (F26) and several pits (F32, F67 and F78). A small group of heat affected small flint stones (five) was also recovered from a pit dated as medieval/post-medieval as well as single, individual pieces that were from a modern layer and unstratified. A piece of sandstone/quartzite from F13, might also have been heat affected.

Slag: There are three pieces of slag (combined weight 199g). One of these (32g), a relatively nondescript piece of iron based slag, comes from Roman pit F67. There is a very small piece of glassy slag from medieval/post-medieval pit F73 and another piece of ferrous based slag (133g) from soil layer L3.

Coke/cinder: Four small pieces (black, vesicular) were recovered, three from postholes F33 and F42, and a single piece of similar cinder material from the upper fill of well F19 (20).

Charcoal: Small pieces of charcoal were recovered from well F19. There is a small roundwood piece from the lower fill (22) and a second similar piece (diameter 12mm) from the upper fill (20).

5.7 Small finds (Appendix 4) by Laura Pooley

Ten metal small finds were recovered from five separate contexts, five from Roman well F19 (with post-medieval/modern settling layers in the mid to upper fill), two from drip-gully F21, and single finds from roundhouse posthole F22, Roman posthole F17 and modern layer L2.

The five small finds from well F19 all came from post-medieval settling layers in the mid to upper fill of the feature which contained residual Roman material. These consisted of four unidentified fragments of copper-alloy sheet (SF7-SF8), a tiny silver disc (SF6), the broken shaft from a probable Roman copper-alloy pin/needle (SF4) and a 'barbarous radiate' of 3rd century date (SF2).

Three small finds were associated with the roundhouse. A 2nd century copper-alloy ?dupondius of Antoninus Pius (SF3) and an unidentified melted lump (SF5) came from gully F21. Four fragments of unidentified copper-alloy sheet were recovered from internal posthole F22 (SF1).

The two remaining small finds were a residual 2nd century coin from modern layer L2 (SF10) and a structural iron fitting from Roman posthole F17 (SF9).

For full descriptions of identified small finds see below, for all others see Appendix 4.

SF2 F19, 18. Silver contemporary copy of a radiate ('barbarous radiate'), probably copying a coin of Victorinus (269-271), Virtus reverse, similar to RIC 78. Most of these copies were struck c 275-85 when there was a shortage of small change in Britain. Obverse: radiate bust right, bearded and draped **IM C [...]INS PF AVG**. Reverse: Virtus, standing facing, helmeted, head right, holding spear in right hand, resting left hand on shield, **VIRTV AVG**. Die axis: 12, 19mm diameter, 2g.

SF3 F21, 19. Copper-alloy ?dupondius of Antoninus Pius, AD 138-161. Obverse: bearded bust right, worn but probably a radiate crown [ANT]ONINVS AVG PIVS PP [...]. Reverse: Very worn, figure standing left, probably holding caduceus, inscription illegible. If a dupondius, likely to be RIC 659, AD 140-144. Die axis: 11, 26mm diameter, 3mm thick, 12g.

SF4 F19, 23. Broken copper-alloy pin/needle shaft, tapering to a point, rest missing. 49mm long, 3.5mm diameter, 1g. Roman.

SF9 F17, 7. Iron double-spiked loop, made by bending a bar with spiked ends to form a loop with parallel arms, for examples see Manning 1985 R34-R47, p130 and plate 61. 80mm long, 25mm wide, 25mm thick, 48g. Roman.

SF10 L2, 45. Copper-alloy dupondius, possibly also of Antoninus Pius, AD 138-161, as the bust is very similar to SF3. Obverse: radiate, bearded, bust right [ANT]ONINV[S...]. Reverse: very worn, figure standing left, probably holding caduceus, inscription illegible but S C visible either side of figure. Die axis: 1. Oval rather than round, 23-26mm, 2mm thick, 8g.

6 Environmental report

by Lisa Gray MSc MA ACIfA Archaeobotanist

Introduction – aims and objectives

Eight samples were presented for assessment. The aims of this assessment are to determine the significance and potential of the plant macro-remains in the samples, consider their use in providing information about diet, craft, medicine, crop-husbandry, feature function and environment.

Sampling and processing methods

Samples were taken and fully processed by Colchester Archaeological Trust, totalling 210 litres of soil. All samples were processed using a Siraf-type flotation device. Flot was collected in a 300-micron mesh sieve then dried.

Once with the author the flots were scanned under a low powered stereo-microscope with a magnification range of 10 to 40x. The whole flots were examined. The abundance, diversity and state of preservation of eco- and artefacts in each sample were recorded. A magnet was passed across each flot to record the presence or absence of magnetised material or hammerscale.

Identifications were made using uncharred reference material (author's own and the Northern European Seed Reference Collection at the Institute of Archaeology, University College London) and reference manuals (such as Beijerinck 1947; Cappers *et al.* 2006; Charles 1984; Fuller 2007; Hillman 1976; Jacomet 2006). Nomenclature for plants is taken from Stace (2010). Latin names are given once and the common names used thereafter.

At this stage, to allow comparison between samples, numbers have also been estimated but where only a very low number of items are present they have been counted. Identifiable charred wood >4mm in diameter has been separated from charcoal flecks. Fragments this size are easier to break to reveal the cross-sections and diagnostic features necessary for identification and are less likely to be blown or unintentionally moved around the site (Asouti 2006, 31; Smart and Hoffman, 1988, 178-179). Charcoal flecks <4mm diameter have been quantified but not recommended for further analysis unless twigs or roundwood fragments larger than 2mmØ were present.

Results (Appendix 5)

The plant remains

Charcoal flecks too small to identify were found in moderate to abundant numbers in each sample. Fragments of wood of identifiable size were found in samples <2>, <3>, <4>, <5> and <7>.

Low numbers of cereal grains were found in samples <2>, <3>, <6> and <7>. These grains consisted of poorly preserved wheat (*Triticum* sp.) with one barley (*Hordeum* sp.) in sample <2>. Only one wheat grain was identifiable to genus. This was one spelt (*T.spelta*) grain in sample <6>. However, even this identification is weak due to the lack of cereal chaff to support it and there only being one grain present.

Uncharred seeds were frequent and only absent from sample <4>. These were seeds of the ruderal plants fat hen (*Chenopodium album*), elderberry (*Sambucus nigra*) and blackberry/raspberry (*Rubus fruticosus/idaeus*).

Fauna

This is not a zooarchaeological report so only general observations of faunal remains are possible here. Low numbers of terrestrial mollusca were found in sample <2> and low numbers of uncharred fragmentary and intact small mammal/reptile bone were found in samples <3> and <5>.

Inorganic remains

Samples <1> and <4> contained low and moderate quantities of magnetic material but no fragments of hammerstone.

Discussion

Biases in recovery, residuality, contamination

Nothing with regards biases in recovery, residuality or contamination was highlighted for any of these samples but each sample contained low to abundant quantities of uncharred, possibly modern rootlet fragments and sample < 2> contained low numbers of the borrowing snail *Ceciliodes acicula* (Müller) This snail burrows well below the ground surface (Kerney & Cameron 1979, 149) and can be indicative of bioturbation and oxygenation of the soil. Conditions like these tend to create aerobic preservation conditions that are biased towards the survival of charred plant remains and uncharred plant remains with robust testas as evident in the samples.

Quality and type of preservation

No waterlogged or mineralised plant remains were found.

Charred plant remains were present, consisting of flecks and fragments of charcoal and charred grains. Charring of plant macrofossils occurs when plant material is heated under '...reducing conditions...' where oxygen is largely excluded (Boardman and Jones 1990, 2) leaving a carbon skeleton resistant to biological and chemical decay (English Heritage 2011, 17). These conditions can occur in a charcoal clamp, the centre of a bonfire or pit or in an oven or when a building burns down with the roof excluding the oxygen from the fire (Reynolds, 1979, 57).

Significance of the samples and recommendations for further work

Where only one or low numbers of charred grains or seeds are found in a 10 to 40 litre sample it is possible that these grains are not associated with the context in which they have been found and that they are intrusive or residual. A recent study of intrusion and residuality in the archaeobotanical record for central and southern England (Pelling et al. 2015) has highlighted the problem of assigning solitary or scarce charred plant macro-remains to the dated contexts they were taken from because it is possible that these durable charred plant remains survived being moved between contexts by human action and bioturbation so cannot be properly interpreted unless radiocarbon dates are gained from the plant macro-remains themselves. That is the only way to secure a genuine date for the charred plant macro-remains like these (Pelling et al. 2015, 96).

For these samples the poor condition of most of these grains suggest that they have been moved around the site within backfill or as general background waste and their connection with the dated contexts in doubtful.

None of these seeds contained internal tissues that would enable germination so it is possible that they are dried waterlogged seeds. Whether they are the same date as the dated context or are in intrusive is difficult to determine. Evidence for bioturbation (see section 4.1) means that seeds may have been moved down into the Roman context from more recent layers. The numbers of these seeds in these samples are abundant but not abundant in high enough quantities to suggest that they are food or craft processing waste.

Therefore no further work is recommended on these samples.

7 Discussion (Figs 10-12)

Archaeological excavation and monitoring at St Mary's School, Kelvedon revealed several significant Roman features. At least one roundhouse existed on the site. Nineteen internal postholes would have formed the structure of the roundhouse with an external drip-gully to collect run-off from the roof. The gully enclosed an area of approximately 12m in diameter, with the roundhouse structure measuring approximately 10m diameter. Quantities of structural fired clay (daub) found in the drip-gully shows that the roundhouse superstructure had included wattles woven between square rails or posts, with squared-timber at the edges and corners.

Dating evidence from the roundhouse would suggest that the structure fell out of use sometime in the mid to late 2nd century and is therefore probably likely to be of late 1st or 2nd century date. It is also likely that the adjacent three-post structure and well are contemporary with the roundhouse. Two lines of postholes to the northeast probably represent fence-lines or fenced-enclosures, however, it is also possible that they may have been part of a rectangular structure.

We know from previous excavations that the development site is located within the northeastern corner of the Roman town of Kelvedon. Several phases of archaeological work have previously taken place in or close to the development site (carried out in the 1960s-80s), within which these current findings must be set. Area codes referred to in this discussion (typed in **bold**) follow those assigned by K Rodwell (1988) (see Fig 10 for locations).

The earliest excavations on the development site itself were carried out in 1968 in advance of the construction of the school. Unfortunately little work was carried out in the area of the school buildings themselves but a series of trenches were excavated, mainly to the east in what was to become the school playing fields (Fig 10, Areas **E** (playing fields) and **F** (school grounds)). Excavation area **F1** revealed what was described as a well-preserved gravel floor and area **F2** a small 2nd-century pit (Rodwell 1988, 12). Trenches in area **E** revealed more gravel surfaces (Fig 10, **E1a** and **E1d**), a 1st century ditch (**E1b**) and rectangular timber building (**E1c**), with the addition of one or more pits in the area defined as **E3** (*ibid*, 55). So, how does this tie-in with results from the current excavation/monitoring areas?

Excavation area **E1a** was identified along the southwestern edge of the current excavation/monitoring area which had cut-through ring-gully F21 (Fig 10). However, there are some obvious differences in results from the 1968 and 2016/7 excavations. In 1968 two patches of gravel surface were identified with a beam slot between the two (*ibid*, 12). In the 2016/7 excavations no trace of a gravel surface was identified. Instead, it seems likely that the high-concentration of natural-gravel spread across the excavation site was identified as metalling by the 1968 excavators. This possibly raises into doubt the existence of metalling also identified nearby in trenches **F1** and **E1d**,

especially as E1d was located just beyond the southeastern edge of the excavation area and no gravel-surface was identified here during current works either. In 1968 no trace was found of the southwestern edge of drip-gully F21 or any associated post-holes, and no trace of the 1968 beam slot was identified by CAT archaeologists, although this might actually have been a continuation of ditch F62.

In 1971 further excavations to the north of area **E1a** revealed a circular structure very similar to the structure present on the current site (Figs 10-12). This structure measured roughly 7.5m in diameter and was of wall-trench construction (meaning the walls of the structure were built within the ring-gully rather than having a separate circle of postholes) (Wilson 1972, 333-4, Fig 11; Rodwell 1988, 55, Fig 42). The wall-trench measured up to 0.6m wide and 0.45m deep. Inside the building was a gravel-floor overlaid with a deposit of burnt structural daub, sealing a scattering of finds interpreted as 'exotic', leading to the identification of the structure as a temple (*ibid*).

Fig 12 compares the two structures side-by-side. The 1971 structure was of wall-trench construction whereas the 2016/7 structure was constructed of timber-posts with an external drip-gully. The 1971 structure measured 7.5m in diameter and the 2016/2017 structure is larger measuring 10m in diameter with the drip-gully at 12m diameter. The 1971 wall-trench measured 0.6m wide by 0.45m deep, whereas the 2016/7 drip-gully measured 0.4-0.7m wide by 0.1-0.28m deep. So although both the wall-trench and drip-gully were broadly similar in width, the drip-gully was much shallower (which possibly explains why it wasn't seen in the 1968 excavations of **E1a**). Both had entrances roughly facing east, measuring approximately 2m wide (1971) and 3.3m (2016/7). Large quantities of structural daub were associated with both examples indicating a wattle-and-daub superstructure, and finds evidence from both show that they had fallen out of use by the end of the 2nd century, with the 1971 structure showing signs of having been burnt down.

A lack of general domestic finds from the 1971 structure and the recovery of a small number of 'exotic' finds (fragment of a pipeclay lion figurine, a plate-brooch and an enamelled bronze fitting) from underneath the burnt daub led to the suggestion that this structure was a circular temple surrounded by a gravel *temenos* within which were votive pits (**E3**), similar to the circular temple at Hayling Island (Rodwell 1988, 136). Other pits of a votive nature were said to have been found close to the temple (ie at **E2**, **C2**) and were therefore probably related (*ibid*, 55, 136) although Eddy questioned how close some of these votive pits/finds actually were (1982, 14). However, the discovery of the 2016/7 structure with its associated well has the appearance of a domestic roundhouse. Does this then call into question the identification of the 1971 structure as a temple? Does the tantalising possibility of a third, albeit small, ring-gully partially uncovered during monitoring indicate the existence of a cluster of domestic roundhouses?

Other examples of roundhouses have been identified at Kelvedon. Approximately 330m to the NNW of the development, excavations in 1985-6 at the Doucecroft site (Clarke 1988, 15-39) revealed two Late Iron Age enclosures, one of which contained a roundhouse. One of these enclosures continued in use into the early Roman period within which was an early Roman roundhouse. This was probably built at a time when Kelvedon was still essentially a native Iron Age settlement, although roundhouses of early Roman date in Essex are not uncommon (*ibid*, 38). Both Doucecroft examples were roundhouses of wall-trench construction like the 1971 example. A third Iron Age roundhouse (a polygonal structure) was identified approximately 130m NNE in an area excavated in the late 1970s (Fig 10, area **C**) (Eddy 1982, 8). These three examples show that, although not common in the Roman period, the use of domestic roundhouses at the St Mary's School site sits within a native tradition at Kelvedon.

Interestingly, previous excavations close to the development site (areas **E1c**, **B**, **C** and **L**, see Fig 10) have also revealed a number of rectangular structures of Iron Age (Eddy

1982, 8) and Roman date (Rodwell 1988). They appear to be timber-framed structures constructed of beam-slots resting on gravel floors, with wattle-and-daub walls and probably thatched roofs (Rodwell 1988, 136). Open-ended structures in areas **B** and **C** appeared to be primarily industrial/agricultural, and the structure in **E1c** domestic (*ibid*). So, rather than fence-lines of fenced-enclosures, do the two parallel lines of postholes on the development form a rectangular structure?

Unlike the previous examples, no beam-slots were identified during this current excavation and the distribution of postholes to the WNW could not be fully investigated, making interpretation difficult. If the postholes did form a rectangular structure, it would have measured at least 10m long by 5.5m wide, with examples from area **B** measuring between 11-24m long by 5.2-6.2m wide (*ibid*, 5-9). However, the one postulated structure made of close-set postholes on area **B** was thought to be of potentially post-Roman date (*ibid*, 9). Five of the postholes on the development site contained dating evidence of a generic 'Roman' date, suggesting that they are not later features, but whether they form a building or a fence-line/fenced-enclosure is difficult to determine. Although, if proved to be a building it would be on the same alignment as the domestic structure in **E1c** 70m NW.

Although the excavation notes area **E3** are lacking in detail, this area should at least partially be located within the current excavation area. **E3** is described as consisting of 'one or more pits, said to be 2m deep' from which came a quantity of pottery, tesserae, some coins and other small finds described as of a 'votive' nature (bronze letters from an inscription, a silver necklace, an intaglio) (*ibid*, 55). The only deep feature identified during the 2016/7 works was well F19. Is this actually the same deep pit excavated in the 1960s/70s? If it is, it might give an alternative explanation as to why modern/post-medieval finds were found scattered amongst Roman material from the mid and upper fill, as these layers would be backfill from the earlier excavation. Unfortunately there is no way to be certain, and the E3 pits could equally be located beyond the 2016/7 areas.

A timber-lined well was recorded to the NNW, within area **C5**. However, although not timber-lined, the size and depth of F19, along with its proximity to the roundhouse, would suggest that it is a well that went out of use at the same time as the roundhouse. The only other deep features located close-by were quarry pits in Rodwell's area **B**, but these were larger and shallower at between 7-8m in length/width and 1-1.8m deep (*ibid*, 5).

One further point of note is the occurrence of a disproportionately large quantity of tessera cubes over the development site when compared to other Roman ceramic building material. Particularly associated with the drip-gully and well, this is not an isolated occurrence as quantities of tesserae were also found during the 1968 excavations in **E1A** and **E3** (*ibid*, 55). There is no evidence to suggest that either of the two round structures had a tessellated floor. The 1971 structure had a gravel-floor and although no trace of a surface had survived in the 2016/7 structure there was no evidence of an associated broken-up mortar base. However, re-used cubes were identified set into the gravel surface of **E1A**. It is perhaps more likely that these cubes are either from the floor of a larger building located near-by, although the lack of other material associated with the demolition of a building of this scale, might suggest that the tesserae had been stripped from a floor(s) elsewhere in the settlement and kept on the site as a dump/stock of material (Benfield, this report).

8 Acknowledgements

CAT thanks Andrew Marchant, Ingleton Wood and St Mary's Primary School for commissioning and funding the work. The project was managed by C Lister, fieldwork was carried out by B Holloway, S Carter, J Dodd, R Mathieson, C Platts, N Rayner, A Wade and B Watson. Figures are by M Baister, S Carter, B Holloway, E Holloway, L Pooley. The project was monitored for ECCPS by Teresa O'Connor.

9 References

- Asouti, E 2006 'Factors affecting the formation of an archaeological wood charcoal assemblage.' Retrieved on 13th February 2015 from World Wide Web: http://pcwww.liv.ac.uk/~easouti/methodology_application.htm
- Beijerinck, W 1947 *Zadenatlas der Nederlandsche Flora*. Veenman and Zonen Wageningen.
- Boessneck, J A 1969 Osteological Differences between Sheep (*Ovis aries*) and Goat (*Capra hircus*). In D R Brothwell & E S Higgs (eds.) *Science in Archaeology* pp 331-358. London: Thames & Hudson.
- Brown, A, Meadows, I, Turner, S & Maitingly, D 2001 'Roman vineyards in Britain: stratigraphic and palynological data from Wollaston in the Nene Valley, England' in *Antiquity* **75**, 745-57
- Cappers, R J T, Bekker, R M & Jans, J E A 2006 *Digital Zadenatlas Van Nederlands - Digital Seeds Atlas of the Netherlands*. Groningen Archaeological Studies Volume 4. Groningen: Barkhius Publishing Groningen.
- CAR 7 2000 *Colchester Archaeological Report 7: Post-Roman pottery from excavations in Colchester, 1971-85*, by J Cotter
- CAT 2014 *Health and Safety Policy*
- CAT 2015 *Written Scheme of Investigation (WSI) for archaeological excavation and monitoring at St Mary's Primary School, Docwra Road, Kelvedon, Essex, CO5 9DS*
- Charles, M 1984 'Introductory remarks on the cereals.' *Bulletin on Sumerian Agriculture* **1**, 17-31.
- ClfA 2014a *Standard and guidance for archaeological excavation*
- ClfA 2014a *Standard and guidance for archaeological watching briefs*
- ClfA 2014b *Standard and guidance for the collection, documentation, conservation and research of archaeological materials*
- Clarke, C P 1988 *Late Iron Age enclosures at Kelvedon: excavations at the Doucecroft site 1985-86*. Essex Archaeology and History **19**, 15-39.
- Cohen, A and Serjeanston, D 1996 *A manual for the identification of bird bones from archaeological sites*. Archetype Publications.
- Cunningham, C 1985 'A typology for post-Roman pottery in Essex' in Cunningham, C., & Drury, P., *Post-medieval sites and their pottery: Moulsham Street, Chelmsford*, CBA Research Report **54**
- Davis, S J M 1992 *A Rapid Method Of Recording Mammal Bones From Archaeological Sites*. English heritage Ancient Monuments Laboratory report 19/92
- DCLG 2012 *National Planning Policy Framework*. Dept of Communities and Local Government.
- Drury, P 1988 *The Mansio and other sites in the south-eastern sector of Caesaromagus*, CBA Research Report **66**
- EAA **14** 2003 *Standards for field archaeology in the East of England*, East Anglian Archaeology, Occasional Papers, **14**. Ed. D Gurney
- EAA **24** 2011 *Research and archaeology revisited: A revised framework for the East of England*, East Anglian Archaeology Occasional Papers **24**, by Maria Medlycott
- ECCPS 2015 *Brief for archaeological excavation on land at St Mary's Primary School, Docwra Road, Kelvedon, Braintree Kelvedon. The origins and development of a Roman small town*. Essex County Council Occasional Paper No 3
- Eddy, M R 1982 *Management of Research Projects in the Historic Environment* (English Heritage)
- English Heritage 2006 *Environmental Archaeology: A Guide to the Theory and Practice of Methods for Sampling and Recovery to Post-Excavation*. Swindon: English Heritage Publications.
- English Heritage 2011
- Fuller, D 2007 'Cereal Chaff and Wheat Evolution' Retrieved on 12th February 2010 from World Wide Web: <http://www.homepages.ucl.ac.uk/~tcrndfu/archaeobotany.htm>
- Going, C 1987 *The Mansio and other sites in the south-eastern sector of*

| | | |
|---|------|--|
| Hillman, G C | 1976 | <i>Caesaromagus: the Roman pottery</i> , CBA Research Report 62 'Criteria useful in identifying charred Wheat and Rye Grains.' Unpublished versions of notes likely to have entered publication in some form and given to the author by Gordon Hillman during her MSc in 1995-1996. |
| Hillson, S | 1986 | <i>Teeth</i> . Cambridge Manuals In Archaeology |
| Hull, M | 1958 | <i>Roman Colchester</i> , RRCSAL 20 |
| Hull, M | 1963 | <i>The Roman potters' kilns of Colchester</i> , RRCSAL 21 |
| Jacomet, S | 2006 | <i>Identification of cereal remains from archaeological sites - second edition</i> . Basel: Basel University Archaeobotany Lab IPAS. |
| Kerney, M P & Cameron R A D | 1979 | <i>Land Snails of Britain and North-West Europe</i> . London: Harper Collins Publishers. |
| Manning, W | 1985 | <i>Catalogue of the Romano-British iron tools, fittings and weapons in the British Museum</i> |
| Payne, S | 1987 | <i>Reference codes for wear states in the mandibular cheek teeth of sheep and goats</i> . Journal of Archaeological Science 14 , 609-614. |
| Pelling, R, Campbell, G, Carruthers, W, Hunter, K & Marshall, P | 2015 | 'Exploring contamination (intrusion and residuality) in the archaeobotanical record: case studies from central and southern England'. In <i>Vegetation History and Archaeobotany</i> . (2015) 24: 85-99. |
| Reynolds, P | 1979 | <i>The Iron Age Farm: The Butser Experiment</i> London: British Museum Press. |
| Rodwell, K A | 1988 | <i>The Prehistoric and Roman settlement at Kelvedon, Essex</i> , CBA Research Report 63 |
| RIC | - | RIC (Roman Imperial Coinage) references taken from www.wildwinds.com |
| Serjeantson, D | 1996 | <i>The Animal Bones</i> . In S. Needham & T. Spence (eds.) <i>Refuse and Disposal at Area 16 East, Runnymede. Runnymede Research Excavations, Volume 2</i> . pp194-223. London: British Museum Press. |
| Silver, I A | 1969 | <i>The Ageing of Domestic Animals</i> . In Brothwell, D.R. and Higgs, E.S. (eds.), <i>Science in Archaeology: A Comprehensive Survey of Progress and Research</i> (London), 283-302. |
| Smart, T & Hoffman, E S | 1988 | 'Environmental Interpretation of Archaeological Charcoal.' In Hastorf, C A and Popper, V S <i>Current Palaeobotany</i> Chicago and London. University of Chicago Press. |
| Stace, C | 2010 | <i>New Flora of the British Isles 3rd Edition</i> Cambridge University Press Cambridge. |
| Warry, P | 2006 | <i>Tegulae, manufacture, typology and use in Roman Britain</i> , BAR British Series 417 |
| Webster, G | 1991 | <i>Archaeologist at large</i> |
| West, S | 1990 | <i>West Stow, The prehistoric and Romano-British occupations</i> , EAA 48 |
| Wilson, D R | 1972 | <i>Roman Britain in 1971</i> . Britannia Volume III , 333-334. |

10 Abbreviations and glossary

| | |
|----------------|---|
| Bronze Age | period circa 2500- 700 BCE |
| CAT | Colchester Archaeological Trust |
| CBM | ceramic building material, ie brick and tile |
| ClfA | Chartered Institute for Archaeologists |
| context | specific location of finds on an archaeological site |
| feature (F) | an identifiable thing like a pit, a wall, a drain: can contain 'contexts' |
| Iron Age | period from 700 BC to Roman invasion of AD 43 |
| later Iron Age | period from c 350 BC to early 1st century AD |
| Late Iron Age | (LIA) period from c 100-50 BC to Roman invasion of AD 43 |
| layer (L) | distinct or distinguishable deposit of soil |
| medieval | period from AD 1066 to Henry VIII |
| modern | period from c AD 1800 to the present |
| natural | geological deposit undisturbed by human activity |

| | |
|---------------|---|
| OASIS | Online Access to the Index of Archaeological Investigations, http://oasis.ac.uk/pages/wiki/Main |
| peg-tile | rectangular thin tile with peg-hole(s) used mainly for roofing, first appeared c AD1200 and continued in use to present day, but commonly post-medieval to modern |
| post-medieval | from Henry VIII to c AD1800 |
| prehistoric | pre-Roman |
| residual | something out of its original context, eg Roman coin in modern pit |
| Roman | period from AD 43 to around AD 410 |
| SCC | Suffolk County Council |
| SCCAS | Suffolk County Council Archaeological Services |
| SCHER | Suffolk County Historic Environment Record |
| section | (abbreviation sx or Sx) vertical slice through feature/s or layer/s |
| U/S | unstratified, ie without a well-defined context |
| WSI | Written Scheme of Investigation |

11 Contents of archive

Finds: 8 boxes (7 bulk finds, 1 small find)

Paper and digital record

One A4 document wallet containing:

The report (CAT Report 1007)

ECC evaluation brief, CAT written scheme of investigation

Original site record (feature and layer sheets, finds record, plans)

Site digital photos and log, architectural plans, attendance register, risk assessment

12 Archive deposition

The paper and digital archive is currently held by the Colchester Archaeological Trust at Roman Circus House, Roman Circus Walk, Colchester, Essex CO2 7GZ, but will be permanently deposited with Braintree Museum under accession code: [tbc](#)

Distribution list:

Andrew Marchant, Ingleton Wood
St Mary's Primary School, Kelvedon
Essex County Council Place Services, Historic Environment Advisor
Essex Historic Environment Record, Essex County Council



Colchester Archaeological Trust

Roman Circus House,
Roman Circus Walk,
Colchester,
Essex, CO2 7GZ

tel.: 01206 501785

email: lp@catuk.org

Checked by: Philip Crummy

Date: 02.10.2017

Appendix 1 Context list

| Context number | Finds number | Context type | Description | Date |
|----------------|--------------------------------|---------------------|--|---|
| F1 | - | Pit | Firm, moist, medium grey/brown sandy-silt with charcoal flecks | - |
| F2 | - | Tree-throw | Firm, moist, medium grey/brown silt | - |
| F3 | 1 | Posthole | Firm, moist, dark grey/brown silt with charcoal flecks | Roman |
| F4 | 2 | Posthole | Firm, moist, dark grey/brown silt with charcoal flecks | Roman, mid 1st-2nd/3rd century |
| F5 | - | Tree-throw | Firm, moist, medium grey silt | - |
| F6 | - | Pit/ posthole | Firm, moist, medium grey/brown silt with charcoal flecks | - |
| F7 | - | Pit/ posthole | Firm, moist, medium grey/brown silt with charcoal flecks | - |
| F8 | - | Posthole | Firm, moist, dark grey/brown silt with charcoal flecks | - |
| F9 | - | Posthole | Firm, moist, dark grey/brown silt with charcoal flecks | - |
| F10 | 3 | Posthole | Firm, moist, dark grey/brown silt with charcoal flecks | Roman, mid 1st-2nd/early 3rd century |
| F11 | - | Pit/ posthole | Firm, moist, medium grey/brown silt with charcoal flecks | ?Roman |
| F12 | - | Pit/ posthole | Firm, moist, medium grey/brown silt with charcoal flecks | ?Roman |
| F13 | 4 | Posthole | Firm, moist, dark grey/brown silt with charcoal flecks | Roman (mid 1st-2nd century?) |
| F14 | | Pit/ posthole | Firm, moist, medium grey/brown silt with charcoal flecks | ?Roman |
| F15 | 5 | Pit/ posthole | Firm, moist, medium grey/brown silt with charcoal flecks | Roman |
| F16 | 6 | Pit/ posthole | Firm, moist, medium grey/brown silt with charcoal and daub flecks | Roman |
| F17 | 7, 8 | Pit/ posthole | Firm, moist, medium grey/brown silt with charcoal and daub flecks | Roman |
| F18 | 9 | Pit | Firm, moist, medium grey/brown silty-clay with charcoal flecks | Roman |
| F19 | 18, 20-26 | Well | Firm, moist, dark grey/brown silt with charcoal flecks | Lower fill: late 2nd/3rd to 4th century. Mid-upper: post-medieval/modern |
| F20 | 10 | Pit | Soft, moist, dark grey/brown sandy-silt with charcoal and daub flecks | Roman, mid 1st-2nd century |
| F21 | 11, 17, 19, 32, 33, 34, 39, 40 | Drip-gully | Soft, moist, dark grey/brown sandy-silt with charcoal and abundant daub flecks, common stone | Roman, mid/late 2nd-3rd/4th century |
| F22 | 12, 13 | Roundhouse posthole | Soft, moist, dark grey/brown sandy-silt with charcoal and daub flecks, 5% stone | Roman |

| | | | | |
|-----|--------|---------------------|---|--|
| F23 | - | Roundhouse posthole | Soft, moist, dark grey/brown sandy-silt with charcoal and daub flecks, 30% stone | Roman |
| F24 | 14 | Posthole | Firm, moist, dark grey/brown silt with charcoal flecks | Roman, mid 1st-2nd/early 3rd century |
| F25 | - | Posthole | Firm, moist, dark grey/brown silt with charcoal flecks | Roman |
| F26 | 15 | Roundhouse posthole | Soft, moist, dark grey/brown sandy-silt with charcoal flecks, 5% stone | - |
| F27 | - | Posthole | Firm, moist, dark grey/brown silt with charcoal flecks | - |
| F28 | - | Posthole | Firm, moist, medium grey/brown silt | - |
| F29 | - | Posthole | Firm, moist, light-medium grey/brown silt | - |
| F30 | - | Posthole | Firm, moist, medium grey/brown silt with charcoal flecks | - |
| F31 | 16 | Pit/ ditch | Firm, moist, medium grey/brown silt with charcoal flecks | Post-medieval, c 17th-18th century |
| F32 | 27, 28 | Pit / ditch | Firm, moist, medium grey/brown/black silt with charcoal and daub flecks | Roman, late 2nd-3rd century |
| F33 | 29 | Posthole | Firm, moist, light-medium grey/brown silt with charcoal flecks | Roman? or more probably post-medieval/modern |
| F34 | 30 | Pit | Firm, moist, medium grey/brown silt with charcoal and daub flecks | Roman, 2nd century |
| F35 | 31 | Posthole | Firm, moist, light-medium grey/brown silt with charcoal flecks | Probably medieval/post-medieval |
| F36 | - | Pit/ posthole | Firm, moist, medium grey/brown silt with charcoal flecks | - |
| F37 | - | Tree-throw | Firm, moist, medium grey silt | - |
| F38 | - | Natural gully | Firm, moist, medium grey/brown silt with charcoal flecks | - |
| F39 | - | - | VOID | - |
| F40 | - | Roundhouse posthole | Firm, moist, medium yellow/mottled grey/brown sandy-silt with charcoal flecks | Roman |
| F41 | - | Roundhouse Posthole | Soft, moist, dark grey/brown sandy-silt with rare charcoal flecks, 5% stone | Roman |
| F42 | 35 | Roundhouse posthole | Soft, dry, dark grey/brown sandy-silt with rare charcoal and daub flecks, 10% stone | Roman? or more probably post-medieval/modern |
| F43 | - | Roundhouse posthole | Soft, moist, dark grey/brown silt | Roman |
| F44 | 36 | Tree-throw | Soft, moist, dark grey/brown silt with charcoal and daub flecks, 5% stone | ?Modern |
| F45 | - | Roundhouse posthole | Soft, moist, dark grey/brown sandy-silt with charcoal flecks | Roman |
| F46 | - | Roundhouse posthole | Soft, dry, medium grey/brown silt | Roman |
| F47 | - | Roundhouse posthole | Firm, moist, medium grey/brown sandy-silt with charcoal and daub flecks, 20% stone | Roman |
| F48 | - | Roundhouse posthole | Soft, moist, medium yellow/brown sandy-silt | Roman |

| | | | | |
|-----|---------|-------------------------|--|---------------------------------------|
| F49 | 37 | Pit/ posthole | Soft, moist, medium grey/brown sandy-silt with rare charcoal and daub flecks, 10% stone | Roman (mid 1st-3rd century?) |
| F50 | - | Roundhouse posthole | Firm, dry, medium grey/brown sandy-silt, 20% stone | Roman |
| F51 | - | Roundhouse posthole | Soft, dry, medium orange/brown/black sandy-silt with charcoal flecks, <5% gravel | Roman |
| F52 | - | Roundhouse posthole | Friable, dry-moist, dark grey silty-sand with 40% stone | Roman |
| F53 | - | Tree-throw | Firm, dry, medium yellow/brown sandy-silt, 10% stone | ?Modern (post-Roman) |
| F54 | 38 | Posthole NOT ON PLAN | Firm, dry, dark grey/brown sandy-silt with charcoal and daub flecks, 5% stone | Roman |
| F55 | - | Pit | Firm, dry, dark grey/brown sandy-silty loam with charcoal and daub flecks, common stones | Modern |
| F56 | - | Roundhouse posthole | Soft, medium brown sandy-silt | Roman |
| F57 | - | Roundhouse posthole | Soft, dry-moist, medium brown/black silty-sand with charcoal and daub flecks | Roman |
| F58 | - | Roundhouse posthole | Soft, moist, medium grey/brown sandy-silt | Roman |
| F59 | - | Roundhouse posthole | Soft, dry-moist, dark grey/brown sandy-silt | Roman |
| F60 | - | Roundhouse posthole | Soft, dry-moist, medium orange/brown silty-sand with daub flecks, 10% stone | Roman |
| F61 | - | Ditch | Friable, moist, dark brown sandy-silt, 15% stone, 15% gravel | Modern/post-medieval |
| F62 | - | Ditch | Friable, moist, dark brown sandy-silt, 15% stone, 10% gravel | Modern/post-medieval |
| F63 | 43a | Gully | Friable/firm, dry, medium grey/brown silty-loamy sand | Roman, mid 1st-2nd century |
| F64 | - | Pit/ posthole | Friable, dry, dark brown/black silty-loam | Not excavated |
| F65 | - | Pit/ posthole | Friable, dry, dark brown/black silty-loam | Not excavated |
| F66 | 44a | Ditch | Friable, dry, dark brown/black silty-loam, <10% gravel, <15% stone | Roman (mid/late 1st-2nd/3rd century?) |
| F67 | 41a, 49 | Pit | Friable, moist, dark brown/black sandy-silt, <5% stone | Roman, early 2nd-3rd century |
| F68 | 42a | Pit | Friable, moist, dark brown/black sandy-silt, <5% stone | Medieval, c 12th-14th century |
| F69 | 43b | Pit | Firm, moist, dark grey/brown silt with charcoal flecks | Roman |
| F70 | 44b, 50 | Pit | Firm, moist, dark grey/brown silt with charcoal flecks | Roman, early 2nd-3rd century |
| F71 | - | Pit | Firm, moist, medium grey/brown silt with charcoal flecks | - |
| F72 | - | Pit/ posthole | Firm, moist, dark grey/brown silt | - |
| F73 | 45a, 48 | Pit | Friable, moist, dark brown/black sandy-silt, 15% stone | Medieval/post-medieval |
| F74 | - | Pit | Firm, moist, dark grey/brown silt with | - |

| | | | | |
|-----|---------|----------------------|---|--|
| | | | charcoal flecks | |
| F75 | - | Pit | Friable, moist, medium grey/brown sandy-silt, 20% stone | - |
| F76 | - | Pit | Friable, moist, medium grey/brown sandy-silt, 20% stone | - |
| F77 | - | Tree-throw | Friable, moist, dark brown sandy-silt, 5% stone | - |
| F78 | 47, 51 | Pit | Firm, moist, dark grey/brown silt with charcoal flecks | Roman, early 2nd-early 3rd/3rd century |
| L1 | - | Hardstanding | Tarmac playground | Modern |
| L2 | 42b | Sub-base | Sub-base of sand and ballast for L1 | Modern |
| L3 | - | Subsoil/accumulation | Firm, moist, medium grey/brown silt with charcoal flecks | Post-medieval/modern |
| L4 | - | Natural | Natural sands and gravels | - |
| L5 | 41b, 52 | Dump | Firm, moist, dark grey/brown silt with ash, clinker, pot, glass etc | Modern |

Appendix 2 Bulk finds list

A/B= abraded/burnt; OR=orange; B=brown; F-MS=fine-medium sand; MS=medium sandstone
Tess=tesserae; RBT=Roman brick/tile; RB=Roman brick; RT=Roman tile; RI=Roman imbrex

| Context | Context type | Find no | Find type | Find period | Fabric | Description | Form | No | Wt/g | EVE (100=1 EVE) | A/B | Spot date |
|---------|-----------------|---------|------------|-------------|-----------------|--|--------------------|----|------|-----------------|-----|--------------|
| F3 | Posthole | 1 | Pot | Rom | BSW (47) | | | 1 | 8 | | | Rom |
| | | | Pot | Rom | 47 | Dark grey fabric with pale grey margins/ surface | | 1 | 4 | | | Rom |
| F4 | Posthole | 2 | Pot | Rom | 44 | Rim | G44 (Cam 273 type) | 1 | 52 | 5 | | M1-2/3C |
| | | | Pot | Rom | 47 | | | 1 | 6 | | | Rom |
| F10 | Posthole | 3 | Pot | Rom | 44 | Rim & body sherd | | 2 | 100 | 12 | | M1-2/E3C |
| F13 | Posthole | 4 | Pot | Rom | 45 | Dark grog/ charcoal flecks | | 1 | 6 | | | E/M-L 1C |
| | | | Pot | Rom | BSW (47) | | | 1 | 3 | | | Rom (M1-2C?) |
| | | | Stone | | Sand/ quartzite | Burnt? | | 1 | 56 | | | |
| F15 | Posthole | 5 | Pot | Rom | BSW (47) | Some thin burnt residue? on exterior | | 1 | 2 | | | Rom |
| F16 | Posthole | 6 | CBM | Rom | OR F-MS | 35mm+ thick | RB | 1 | 96 | | | Rom |
| | | | Fired clay | Rom | | Abraded small, rounded pieces, silty-sand fabrics most buff-brown some brownish-red | | 10 | 28 | | A | |
| F17 | Posthole | 7 | CBM | Rom | OR F-MS | Fragment | Tess | 1 | 8 | | | Rom |
| | | | Fired clay | Rom | OR/B MS FL/Q | Some abrasion, S M & M-L pieces, some coarse white flint/quartz sand, one M-L piece with flat surface and wattle void c 25mm+ dia, one other M piece with flat surface. The small pieces are rounded and abraded | | 30 | 442 | | (A) | |
| | | | Nails | Rom | | Corroded pieces almost certainly part of nails | | 5 | | | | |
| F18 | Pit | 9 | CBM | Rom | OR F-MS | Broadly square/squarish tessera cube, c 20-25mm sq, no traces of white base mortar adhering | Tess | 3 | 48 | | | Rom |
| | | | CBM | Rom | OR F-MS | Roman brick/tile | RBT | 1 | 302 | | | Rom |
| | | | Nail | | Fe | Corroded nail head & shaft pieces (probably Manning 1b if Roman) | | 1 | | | | Rom |
| F19 | Pit, upper fill | 20 | Pot | Rom | GX | Small sherd with lime (water) scale on inside | | 1 | 4 | | | Rom |
| | | | Pot | Rom | 55 | Dressel 20, body sherd | D 20 | 1 | 230 | | | M1-2/E3C |
| | | | Pot | Rom | 45G | Handle from a stoneware vessel, probably English rather than German | | 1 | 26 | | | 18-19C(?) |
| | | | Pot | Rom | 2 | Off-white fabric, chipped orange slip | B6 (Cam 305) | 1 | 28 | 7 | A | L3-4C |
| | | | Pot | Rom | 44 | Sherds from a minimum of 2 pots | | 5 | 170 | | | M1-3C |
| | | | Pot | Rom | 44 | Moderately soft orange fabric with some grog and organic fragments, possibly partly hand made, some dragging of temper in surface | | 1 | 18 | | | E/M1-E2C |

| Context | Context type | Find no | Find type | Find period | Fabric | Description | Form | No | Wt/g | EVE (100=1 EVE) | A/B | Spot date |
|---------|--------------|---------|-----------|--------------------|------------------|---|--------------|-----|------|-----------------|---------|---------------|
| | | | Pot | Rom | 4 | | | 1 | 8 | | A | L3-4C |
| | | | Pot | Rom | 40 | Rim from a jar (Cam 27B/C), one other possibly also Fabric 40 | | 2 | 18 | 3 | | L2-4C |
| | | | Pot | Rom | 41 | Bowl with curving plain wall- rim sherd, two other sherds | B1 (Cam 39B) | 3 | 20 | 3 | | E2-3C |
| | | | Pot | Rom | BSW (47) | misc | | 4 | 32 | 5 | | |
| | | | Pot | Rom | 47 | misc | | 34 | 171 | | | Rom |
| | | | Pot | Rom | 48 | Greyware with some burnt quartz/flint, possibly Rettendon-type ware | | 1 | 6 | | | 3-4C |
| | | | Pot | Rom/ p- med? | 21 (p-med 21/40) | Abraded sherd, orange fabric grey core, possibly post-medieval | | 1 | 14 | | A | Rom/ p-med? |
| | | | Pot | Rom | 47 | Rim, jar, neckless with bead rim | | 1 | 10 | 5 | (A) | |
| | | | Pot | Rom | GROG | Base edge sherd, common dark grog | | 1 | 20 | | | E-M1C |
| | | | Pot | Rom | GROG | Small hand-made sherds with part of a cordon and stab mark | | 1 | 4 | | | L1 BC-E1 AD |
| | | | Pot | p-med | 40 | Single sherd, glazed inside only | | 1 | 8 | | | 16/17-18C |
| | | | CBM | Rom | OR F-MS | 10-16mm thick | RI | 13 | 842 | | | Rom |
| | | | CBM | Rom | OR F-MS | 35-45mm thick | RB | 5 | 794 | | | Rom |
| | | | CBM | Rom | R/BR MS | Possibly brick rather than roof tile, one edge piece, noticeably sandy fabric, 30mm thick | RB | 4 | 1112 | | | Rom |
| | | | CBM | Rom | OR F-MS | Pieces from tegula tiles, 22-25mm thick. One with thin flange, probable LCA passing through flange top, Warry Type C4, C5 or D15 (dated ?M2-4C); second small piece from a LCA. (May just be very thin – one other thin flange found) | RT | 7 | 948 | | | prob M2C+ |
| | | | CBM | Rom | OR F-MS | Base with flange, very small flange, 15mm thick | RT | 1 | 162 | | | Rom |
| | | | CBM | Rom | OR F-MS | 14-22mm thick, one piece (128g) appears lightly discoloured by heat, one piece (38g) abraded | RBT | 10 | 866 | | B? A | Rom |
| | | | CBM | Rom | OR F-MS | Flat tile pieces, probably mostly tegula base pieces | RBT | 7 | 552 | | | Rom |
| | | | CBM | Rom | OR F-MS | Orange red, broadly square/squarish cubes c 20-25mm sq by 13-15mm thick, includes 38 with mortar around edges, a half cube, a trapezoidal-shaped tessera, some in a slightly silty fabric and two clearly made from imbrex tiles | Tess | 125 | 2192 | | | Rom |
| | | | CBM | Rom | C F/Ms | Tesserae cubes, top broadly square/squarish, c 20-35mm sq by 15mm thick | Tess | 2 | 34 | | | Rom |
| | | | CBM | Rom | OR F-MS | Irregular small pieces and broken fragments of tesserae cubes or intended tesserae cubes, one in slightly orange silty fabric | Tess | 36 | 380 | | | Rom |
| | | | CBM | p-Rom | OR F-MS | Thin tile (c 10mm), appears to be peg-tile, one with | PT | 12 | 248 | | | ?L med- p-med |

| Context | Context type | Find no | Find type | Find period | Fabric | Description | Form | No | Wt/g | EVE (100=1 EVE) | A/B | Spot date |
|---------|---------------|---------|------------|--------------|----------|--|---------------|----|------|-----------------|-----|----------------|
| | | | | | | peg-hole, one with lipped/nibbed edge | | | | | | |
| | | | Quern | Rom | lava | Small piece, slightly abraded, one flat surface (imported lava) | | 1 | 60 | | | Rom |
| | | | Shell | | | Oyster shells, eight mostly complete (half) shells | | 9 | 206 | | | |
| | | | Abone | | | Animal bone, misc | | | | | | |
| | | | Char-coal | | | Small roundwood piece of charcoal, diameter 12mm | | 1 | | | | |
| | | | Cinder | | | Small piece of black, hard, cinder-like material | | 1 | 14 | | | P-med? |
| | | | Fired clay | Rom? | OR S VT | Irregular lump, coarse vegetable-temper impressions | | 1 | 30 | | (A) | |
| | | | Mortar | | | Buff, sandy common chalk piece, irregular pieces | | 3 | 308 | | | |
| | | | Nails | Rom | fe | Group of 7-8 iron nails (9 pieces), 40-55 mm long, two with bent shafts, flat rounded heads (if Roman, Manning type 1b) | | 9 | 78 | | | Rom? |
| | | | Clay pipe | p-med | | Small stem piece | | 1 | 2 | | | prob c 19-E20C |
| | Pit, mid fill | 21 | Pot | Rom | 44 | Thick, tempered grey fabric | Store jar | 1 | 94 | | | M/L1-2C |
| | | | Pot | L med/P-med? | 21 | Small sandy orange ware, possibly late medieval/early post-medieval | | 1 | 4 | | | L med/P-med? |
| | | | Pot | Rom | 47 | | Jar? | 1 | 18 | | | Rom |
| | | | Pot | Rom | 48 | Greyware with some burnt quartz/flint, possibly Rettendon-type ware | | 1 | 2 | | | 3-4C |
| | | | Pot | Rom | 2 | Sherd from a beaker with a tall neck, pale orange fabric dark surface | Beaker | 1 | 8 | | | M3-4C |
| | | | Pot | Rom | 47 | Light grey fabric | B6 (Cam 305B) | 1 | 36 | 11 | | L3-4C |
| | | | Pot | Rom | 47 | Grey sandy fabric (similar to BB1), two joining sherds, black surfaces abraded or some black slip remaining, some might be burnt residue | B6 (Cam 305B) | 2 | 38 | 15 | | L3-4C |
| | | | Pot | Rom | 47 | Small rim section from a flanged bowl, brownish-red fabric, grey surface | B6 (Cam 305B) | 1 | 4 | 2 | | L3-4C |
| | | | Pot | Rom | 47 | Sandy fabric, smoothed surface abraded back to orange fabric margins | B1 (Cam 39B) | 2 | 26 | 11 | | E2-4C |
| | | | Pot | Rom | 4 | Body sherds | | 2 | 8 | | | L3-4C |
| | | | Pot | Rom | BSW (47) | Jar rim, red-brown fabric, beaded, slightly under cut, burnt residue on surface and over rim | G24 | 1 | 30 | 16 | | E2-4C |
| | | | Pot | Rom | BSW (47) | Jar rim, grey-brown fabric, beaded, slightly under cut, burnt residue on surface and over rim | G24 | 1 | 16 | 8 | | E2-4C |
| | | | Pot | Rom | 47 | Misc sherds, some burnt residue on surfaces | | 5 | 52 | | | Rom |
| | | | Pot | Rom | BSW (47) | | | 1 | 6 | | | Rom |

| Context | Context type | Find no | Find type | Find period | Fabric | Description | Form | No | Wt/g | EVE (100=1 EVE) | A/B | Spot date |
|---------|-----------------|---------|-----------|-------------|-------------------|---|---------|----|------|-----------------|-----|--------------------------|
| | | | Pot | Rom | 21 | Upper body/neck sherd with roller-stamp band and wavy line below, oxidised, matt surface (not slipped or burnished) grey-brown fabric. This combination of decoration occurs on oxidised pots from Colchester (CAR 10 Fabric DJ, fig 6.28) | | 1 | 30 | | | 3C? |
| | | | CBM | Rom | OR F-MS | | RI | 6 | 878 | | | Rom |
| | | | CBM | Rom | OR/G F-MS WCF | Two pieces with grey surfaces, possibly slightly overfired, includes some clarified white flint | RI | 3 | 264 | | | Rom |
| | | | CBM | Rom | OR F-MS | Roman brick/tile, up to c 32mm thick, one overfired grey, one with part of rounded/ abraded edge possibly from deliberate use or from wear, one with part of arched finger marking | RBT | 14 | 1095 | | | Rom |
| | | | CBM | Rom | OR F-MS | Probably from Lydion bricks, 45 & 50mm thick | RB | 2 | 1044 | | | Rom |
| | | | CBM | Rom | OR F-MS | 35 (x2) & 50mm thick | RB | 3 | 740 | | | Rom |
| | | | CBM | Rom | OR F-MS | Four pieces of tile, 15-20mm thick; one (198g) appears burnt along one flange side – poss built as scrap tile into an oven feature (flange ht. 40mm); one (408g) tegula with lower cut away, Warry Type C5/D15, some discolouration from heating across breaks (reused) | RT | 4 | 820 | | | L2-3/4C |
| | | | CBM | Rom/p -Rom | OR F-MS | Three small pieces of tile, thin 9–11mm, thin Roman or peg-tile | RBT/PT | 3 | 35 | | | Prob Rom (not clear) |
| | | | CBM | Rom | OR F-MS | Broadly square/squarish tessera cube, c 20-25mm sq by 13-15mm thick, includes eight with traces of a white mortar adhering, one appears to be part of a tegula flange, some have slightly silty fabric, plus three small pieces probably from broken cubes (22g) | Tess | 74 | 1302 | | | Rom |
| | | | CBM | Rom | C/B FS | Large broadly squarish tessera cube made from cream/buff tile, relatively fine fabric, 20 x 25mm by 25mm thick) | Tess | 1 | 30 | | | Rom |
| | | | Abone | | | Quantity of medium-large mammal, including scapula from cattle? | | | | | | |
| | | | Glass | P-med/mod | | Dark green glass, evenly curving bottle sherd | Bottle? | 1 | 6 | | | P-med/mod - probably mod |
| | | | Nails | | Fe | Corroded nail shaft pieces (probably all Manning 1b if Roman), maximum surviving length 90mm | | 4 | | | | Rom |
| | | | Nails | Rom | Fe | Small quantity of nail pieces, rounded flat heads, Manning Type 1b | | 5 | | | | |
| | | | Mortar | Rom | OR F-MS | Opus signinum mortar – small piece | | 1 | 10 | | | Rom |
| | Pit, lower fill | 22 | CBM | Rom | Cream fabric (AJ) | Tesserae cube, c 20-25mm sq by 18mm thick | Tess(?) | 1 | 16 | | | Rom |

| Context | Context type | Find no | Find type | Find period | Fabric | Description | Form | No | Wt/g | EVE (100=1 EVE) | A/B | Spot date |
|---------|--------------|---------|------------|-------------|----------|--|-----------------|----|------|-----------------|-----|---------------|
| | | | Pot | Rom | 4 | Body sherd | | 1 | 6 | | | L3-4C |
| | | | Pot | Rom | 47 | Sandy greyware | B6 (Cam 305B) | 1 | 14 | 7 | | L3-4C |
| | | | Pot | Rom | 47 | Romano-Saxon-type, parts of two pushed out bosses divided by a vertical groove, small part of groove at right-angle above, grey fabric with common grey & clear quartz sand, burnished grey surface | | 1 | 8 | | | 4C/L4C |
| | | | Pot | Rom | 41 | Dish/bowl rim | B2.11 (Cam 38B) | 1 | 10 | 6 | | L2-3C |
| | | | Pot | Rom | 47 | Rim from a lid seated jar in greware, smooth surface (CAR 10 fig 6.80 & p403misc. lid seated jars not common, recorded from contexts dating to the 2nd-4th century) | G5 | 1 | 16 | 14 | | 2-3C |
| | | | Pot | Rom | 40 | Base sherd dish/bowl | | 1 | 4 | | | E2-4C |
| | | | Pot | Rom | 47 | Misc. body sherds | | 8 | 70 | | | Rom |
| | | | Pot | Rom | BSW (47) | | | 1 | 8 | | | |
| | | | Pot | Rom | 45 | Fabric contains some fragments of burnt organic matter/charcoal and grog? | | 1 | 8 | | | Rom (M1-E2C?) |
| | | | Pot | Rom | 21 | Sandy red ware, appears possibly to be a Hadham product | | 1 | 8 | | | Rom (L3-4C?) |
| | | | CBM | Rom | OR MS | Includes large pieces in a sandy fabric | RI | 3 | 884 | | | Rom |
| | | | CBM | Rom | OR F-MS | Edge piece possibly from small brick (pedalis? size) although not clear, 33mm thick | RB | 1 | 220 | | | Rom |
| | | | CBM | Rom | OR F-MS | Includes two pieces possibly from a small brick (24mm) (pedalis?), heat affected, others c 17mm thick | RBT | 5 | 718 | | (B) | Rom |
| | | | CBM | Rom | OR F-MS | Tile piece & fragments, c 24mm thick | RT | 6 | 192 | | | Rom |
| | | | CBM | Rom | OR F-MS | Flange piece (flange height 35mm), 15-16mm thick | RT | 1 | 236 | | | Rom |
| | | | CBM | Rom | OR F-MS | Broadly square/squarish tesserae cubes, c 20-25mm sq x 13-15mm thick, includes 14 with traces of white mortar on base, some in orange silty fabric, and one large square cube 25 x 20mm (surface) by 28mm thick. Plus six fragments of broken tesserae (80g) | Tess | 39 | 761 | | | Rom |
| | | | Nails | | Fe | Corroded nail shaft pieces (probably all Manning 1b if Roman), maximum surviving length c 60mm | | 3 | | | | Rom |
| | | | Abone | | | Small quantity of large bone pieces – ?cattle | | | | | | |
| | | | Char-coal | | | Small roundwood piece of charcoal | | 1 | | | | |
| | | | Fired clay | Rom | OR/B MS | One finger shaped piece forming part of a cone? two other rounded lumps | | 3 | 68 | | | Rom |

| Context | Context type | Find no | Find type | Find period | Fabric | Description | Form | No | Wt/g | EVE (100=1 EVE) | A/B | Spot date |
|---------|---|---------|------------|-------------|------------|--|---------------------|----|------|-----------------|-----|----------------|
| | | | Quern | Rom | Lava stone | Small piece of imported grey lava – from a quernstone | | 1 | 12 | | | Rom |
| | Pit, mid fill, finds from enviro sample | 25 | Pot | Rom | BSW (47) | Body sherds, probably from jars/deep bowls | Jar/bowl | 3 | 26 | | | Rom |
| | | | Pot | Rom | 39 | Sherd from a panel-dot beaker in moderately fine grey fabric | H5/H6 (Cam 122/123) | 1 | 4 | | | L1(Favian)-2C |
| | | | Pot | Rom | 47 | Base, sandy, abraded | | 1 | 6 | | A | Rom |
| | | | Pot | Rom | 41 | Bowl with curving plain wall- rim sherd | B1 (Cam 39B) | 1 | 6 | 4 | | E2-3/4C |
| | | | Pot | Rom | 40 | Very sandy fabric probably Fabric 40, acute lattice | G9 (Cam 279A) | 1 | 8 | | | E2-L2C |
| | | | CBM | Rom | OR F-MS | Rather grey colour | RBT | 1 | 42 | (thick 15 mm) | | Rom |
| | | | CBM | Rom | OR F-MS | Broadly square/squarish tesserae cubes, c 20-25mm sq x 13-15mm thick, includes two with traces of white mortar on base, some in an orange silty fabric | Tess | 8 | 146 | | | Rom |
| | | | Abone | Rom | | bird | | 1 | | | | |
| | | | Clay pipe | P-med/mod | | Small stem piece, bore c 1-1.5mm diameter | | 1 | 2 | | | prob c 19-E20C |
| | Pit, upper fill | 26 | Glass | P-med/mod | | Very dark green glass, evenly curving bottle sherd | Bottle? | 1 | 4 | | | probably mod |
| F20 | Pit | 10 | CBM | Rom | OR F-MS | Broadly square/squarish tessera cube, c 20-25mm sq, no traces of white base mortar adhering | Tess | 1 | 18 | | | Rom |
| | | | Fired clay | | OR/G-Br MS | Abraded piece with pale orange surface | | 1 | 6 | | A | |
| | | | Pot | Rom | 44 | | | 1 | 28 | | | M1-2C |
| | | | Pot | Rom | 45 | Sherds from two pots, inclusions of dark grog/ charcoal-burnt organic | | 3 | 22 | | | E/M1-L1/E2C |
| F21 | Roundhouse drip-gully, sx1 | 11 | Pot | Rom | 47 | Everted jar rim, probably a BB-type jar (Cam 278?) | G9.1 / G9.2(?) jar | 1 | 14 | 11 | | 2-3C |
| | | | Pot | Rom | 39? | Thick sherd, grey fabric with off-white margins and grey (slipped) surface | | 1 | 12 | | | |
| | | | Pot | Rom | USCC | Thin walled sherd from a beaker, pale grey fabric with orange margins, brownish cc, possibly Nene Valley | | 1 | 2 | | | 2-3C |
| | | | Pot | Rom | 36(?) | Dark greyware sherd, fine sand similar to Hadham fabric or possibly west stow | | 1 | 10 | | | |
| | | | Pot | Rom | 36(?) | Sherd suggests relatively large beaker with traces of dot panel decoration, fabric fine sandy – similar | H5/H6 (?) (Cam | 1 | 18 | | A | L1-2C |

| Context | Context type | Find no | Find type | Find period | Fabric | Description | Form | No | Wt/g | EVE (100=1 EVE) | A/B | Spot date |
|---------|----------------------------|---------|------------|-------------|-----------|---|-----------|----|------|-----------------|-----|-----------|
| | | | | | | to Hadham, sherd or possibly west stow, although this form is not associated with the kilns at West Stow the one published example there probably being a Wattisfield product (West 1990, fig 79 no 207) | 122/123?) | | | | | |
| | | | Pot | Rom | 55 | Small sherd/ flake probably from a Dressel 20 amphora | | 1 | 1 | | (A) | M1-2/E3C |
| | | | Pot | Rom | 47 | Greyware sherd/ sherd flake | | 1 | 2 | | | Rom |
| | | | Pot | Rom | 47 | Sherd from a folded beaker, abraded | Beaker | 1 | 4 | | A | M/L2-3/4C |
| | | | CBM | Rom | OR F-MS | Broadly square/squarish tessera cubes, c 20mm sq, one with finger signature fragment from tile surface, no traces of white base mortar adhering, one in silty fabric | Tess | 4 | 72 | | | Rom |
| | | | Fired clay | Rom | Buff F-MS | Small piece in buff sandy fabric, flat surface surviving | | 1 | 14 | | (A) | |
| | Roundhouse drip-gully, sx2 | 17 | Pot | Rom | 47 | Base and body sherds from two pots, sand fabrics with small-medium translucent quartz, traces of white slip trail down interior of one sherd that is probably comes from close to base of pot | | 3 | 152 | | | Rom |
| | | | Fired clay | Rom | Buff F-MS | Structural daub: Occasional small stones/flinty sand but mostly rather silty (sandy silt fabric). Quite broken up, most are abraded pieces with just a few flat areas of surface. some rounded abrasion, two pieces with grey vitrified surface , one piece with a clear part wattle void, 7 or so pieces with flat area probably a surface One piece with clear wattle voids, possibly one other (15mm+ & 25mm+). Two pieces that are from right angle corner edges. | | 52 | 810 | | | |
| | Roundhouse drip-gully, sx3 | 34 | Pot | Rom | 1(?) | Sherds from a barbotine decorated pot. (Fabric CZ CAR 10) notes: The pieces appear probably all to belong to one pot and this may also be likely given the size and unusual nature of the decoration making this a rare vessel. The pieces (of which three join) have parts of a scene of running animals, a stag can be clearly identified, among vines identified by a triangular bunch of grapes and vine leaves on plant tendrils. One sherd has an out-stretched human arm, clothed with a sleeve ending at the elbow, holding upright a thin staff or wand (possibly a spear) tipped with a trefoil head. It is this sherd that has a small part of the | Beaker? | 7 | 132 | | | 2C |

| Context | Context type | Find no | Find type | Find period | Fabric | Description | Form | No | Wt/g | EVE (100=1 EVE) | A/B | Spot date |
|---------|----------------------------|---------|-------------|-------------|--------------|---|------|-----|-------|-----------------|-----|-------------|
| | | | | | | <p>broken rim base surviving suggesting a cornice rim beaker. It is notable that the figure is not the same proportion as the animal figures, being larger.</p> <p>The pot can be closely compared with vessels from Colchester, recovered during the excavation of Roman kilns on the west side of the town in the 1950's. One, a bowl, is in a similar sounding 'hard, dark grey ware' has a frieze of animals, including a stag, also progressing right to left amid vines around a bowl (Hull 1963, fig 53 no. 9). Another, in a more typical colour-coated ware, has human figures among vines, including one with a radiate head dress and holding onto vines stems or holding vine stem pieces (Hull 1963, fig 53 no. 13).</p> | | | | | | |
| | | | Pot | Rom | 47 | Sherd from large pot, appears heat affected/scorched, sandy fabric with common white quartz sand | | 1 | 40 | | (B) | Rom |
| | | | CBM | Rom | OR F-MS | Broadly square/squarish tessera cubes, c 20-25mm sq by 13-15mm thick, includes one with a finger signature fragment (from original tile surface) and one made from a tegula flange top, some in a slightly silty fabric, no traces of white base mortar adhering | Tess | 46 | 814 | | | Rom |
| | | | CBM | Rom | OR F-MS | Base edge, 18-20mm thick | RT | 1 | 140 | | | Rom |
| | | | CBM | Rom | OR F-MS | Small flat square piece, probably imbrex and possibly intended as a tesserae cube | RI | 1 | 22 | | | Rom |
| | | | Fired clay | Rom | OR/BUFF F-MS | Occasional small flint stones & flinty sand but mostly rather fine sand (sandy silt fabric). Moderate fragments of organic matter mostly visible in surfaces but present in fabric, some longish pieces (not short chaff) with occasional small voids. Commonly slightly rounded (lightly abraded) edges. | | 236 | 11000 | | | Rom |
| | | | Fired clay? | Rom | OR F-MS | Dense fabric similar to Roman tile, possibly just soft tile | | 1 | 40 | | A | Rom |
| | | | Fired clay? | Rom | OR-buff F-MS | Moderately dense fabric, edges indication possible corner edge piece, possibly just soft tile? | | 1 | 32 | | A | Rom |
| | | | Nails | Rom | Fe | Corroded nails, head with shaft pieces (probably all Manning 1b if Roman), maximum surviving length c 55mm | | 3 | | | | Rom? |
| | | 40 | Nails | Rom | Fe | Little corrosion, complete nail, length 55mm, Manning type 1b | | 1 | | | | Rom? |
| | Roundhouse drip-gully, sx4 | 33 | Pot | Rom | 47 | Includes rim from small bowl/jar | | 8 | 106 | 13 | | Rom (E2C+?) |
| | | | Pot | Rom | BSW (47) | On flat smooth base sherd may be from BB-type | | 4 | 32 | | | Rom (E2C+?) |

| Context | Context type | Find no | Find type | Find period | Fabric | Description | Form | No | Wt/g | EVE (100=1 EVE) | A/B | Spot date |
|---------|---------------------|---------|-------------|-------------|-------------------|--|-----------------|----|------|-----------------|-----|---------------------|
| | | | | | | bowl (glitters with fine quartz sand, not mica) | | | | | | |
| | | | Pot | Rom | 27 | Probably Colchester, flagon top, ring-type | | 1 | 4 | 10 | | M/L1-E/M2C |
| | | | CBM | Rom | OR F-MS | Broadly square/squarish tessera cubes, c 20-25mm sq by 13-15mm thick, no traces of white base mortar adhering, some in a slightly silty fabric | Tess | 10 | 172 | | | Rom |
| | | | Fired clay | Rom | R/BufF M/CS FI | two sandy, flat pieces with common white flint inclusions, flat surfaces | | 2 | 44 | | | Rom |
| | | | Fired clay | Rom | OR/BUFF F-MS | Structural daub: Occasional small flint stones & flinty sand but mostly rather fine sand & silt (sandy-silt fabric). Some rare fragments of organic matter, some longish pieces (not short chaff). Occasional small voids. Commonly rounded (abraded) edges. One or two probable wattle voids, but most part circular indentations appear on the edges of slab-like pieces c 30mm thick. Few pieces dark grey-buff, most red/orange-red and red-buff. | | 31 | 1086 | | | Rom |
| | | | Nails | Rom | Fe | Corroded, part nail (length 40mm), Manning type 1b | | 1 | | | | Rom |
| F22 | Roundhouse posthole | 13 | Fired clay | | OR/B MS FL/Q | Some coarse white flint/quartz sand & small stone | | 1 | 6 | | A | |
| | | | Nail | Rom | Fe | Corroded pieces, joining (length 60mm), Manning 1b | | 5 | | | | |
| F24 | posthole | 14 | Pot | Rom | 55 | Body sherd Dressel 20 | D 20 | 1 | 14 | | | M1-2/E3C |
| F26 | Roundhouse posthole | 15 | Burnt stone | | Flint | Burnt large pebble (flaking pieces) (NR) | | 1 | 95 | | | |
| F31 | Pit/ ditch | 16 | CBM | P-Med | OR M/M- C S | Small pieces in coarse sand fabric possibly brick rather than Roman tile | ?BR | 2 | 16 | | | Prob p-med |
| | | | Pot | p-med | 40 | Small sherd, internal glaze | | 1 | 2 | | | c 17th-18th century |
| | | | Pot | p-med | 40B | Small sherd | | 1 | 2 | | | c 17th century |
| F32 | Pit/ ditch | 27 | Burnt stone | | flint | NR | | 1 | 98 | | | |
| | | | Fired clay | Rom | O & OBr MS | Small-medium abraded, rounded pieces, no original surfaces | | 13 | 106 | | A | |
| | | | CBM | Rom | OR F-MS | Medium-large pieces, c 15mm thick | RI | 4 | 1000 | | | Rom |
| | | | Pot | Rom | 41 | Bowl with rounded rim | B4 (Cam 37B) | 1 | 12 | 6 | | L2-3C |
| | | | Pot | Rom | BSW (47) | | | 1 | 8 | | | Rom |
| | | | Pot | Rom | 47 | | | 1 | 12 | | | Rom |
| F33 | posthole | 29 | Coke/ | | | Small black vesicular pieces, appear to be | | 2 | 1 | | | Rom? or more |

| Context | Context type | Find no | Find type | Find period | Fabric | Description | Form | No | Wt/g | EVE (100=1 EVE) | A/B | Spot date | |
|---------|---------------------|---------|-------------|-------------|---------------|---|------|----|------|-----------------|-----|------------------|-----|
| | | | Cinder | | | coal/coke cinder | | | | | | prob p-med/mod | |
| F34 | Pit | 30 | CBM | Rom? | OR F-MS | Fragments, probably Roman | | 4 | 6 | | | Rom? | |
| | | | Pot | Rom | SACG | Base sherd | | 1 | 2 | | | 2C | |
| | | | Pot | Rom | 31 | Small sherd | | 1 | 4 | | | M1-2C | |
| | | | Pot | Rom | GROG | Part burnished surface | | 1 | 2 | | | L1C BC/E-M1C AD | |
| | | | Pot | Rom | 21 | Carinated sherd | | 1 | 6 | | | M1-2C? | |
| F35 | Posthole | 31 | CBM | Med/p-med | OR F-MS | Thin flat tile, probably peg-tile | PT? | 1 | 18 | (thick 13mm) | | Prob med/ p-med | |
| F42 | Roundhouse posthole | 35 | CBM | Rom | Buff (AJ?) | Broadly square/squarish tessera cube, c 20-25mm sq, no traces of white base mortar adhering, this is possibly made from amphora | Tess | 1 | 16 | | | Rom | |
| | | | CBM | Rom | OR F-MS | Broadly square/squarish tessera cube, c 20-25mm sq, no traces of white base mortar adhering | Tess | 2 | 26 | | | Rom | |
| | | | CBM | Rom | OR/G F-MS WCF | Small piece with grey surfaces, possibly slightly overfired – includes some calcified white flint | RI | 1 | 34 | | | Rom | |
| | | | Coke/cinder | | | Black vesicular piece, appears to be coal/coke cinder – probably post-med/modern and intrusive | | 1 | 4 | | | Rom? | |
| | | | Fired clay | Rom | OR MS | Abraded flat surface? Part of rounded wattle void probably 25mm+ diameter | | 1 | 28 | | | (A) | |
| | | | Fired clay | Rom | OR/G-Br/B MS | Surface and part of wattle void (c 20-25mm diameter) | | 1 | 50 | | | (A) | |
| | | | Pot | Rom | 47 | | | | 1 | 2 | | | Rom |
| F44 | Tree-throw | 36 | CBM | Rom | OR F-MS | Broadly square/squarish tessera cube, c 20-25mm sq, no traces of white base mortar adhering | Tess | 1 | 22 | | | Rom | |
| F49 | Pit/posthole | 37 | CBM | Rom | OR F-MS | Broadly square/squarish tessera cube, c 20-25mm sq, no traces of white base mortar adhering | Tess | 1 | 20 | | | Rom | |
| | | | Pot | Rom | BSW (47) | Probably a bowl form | | 1 | 8 | 7 | | Rom (M1-3C?) | |
| | | | Pot | Rom | 47 | Grey surface, brownish orange fabric | | 2 | 6 | | (A) | | |
| F54 | Posthole | 38 | Pot | Rom | 47 | | | 1 | 2 | | (A) | Rom | |
| F63 | Gully | 43a | Pot | Rom | 44 | (recently broken into two) | | 1 | 54 | | A | M1-2C | |
| | | | Pot | Rom | BSW | | | 1 | 4 | | | Rom | |
| F66 | Ditch | 44a | Pot | Rom | BSW | Jar rim, beaded, burnished over rim top | Jar | 1 | 8 | 12 | | Rom (M/L1-2/3C?) | |
| F67 | Pit | 41a | Pot | Rom | SACG | | | 1 | 6 | | A | 2C | |
| | | | Pot | Rom | 44 | | | 1 | 6 | | | M1-2C | |
| | | | Pot | Rom | 47 | | | 3 | 36 | | | Rom | |
| | | | Slag | Rom? | | Irregular slag piece, rough sandy surface, some orange-brown iron content | | 1 | 32 | | | | |
| | | | Fired clay | Rom? | | Small piece, oven/ kiln lining – hard fired clay piece, grey, vesicular, near vitrified surface with | | 1 | 8 | | | | |

| Context | Context type | Find no | Find type | Find period | Fabric | Description | Form | No | Wt/g | EVE (100=1 EVE) | A/B | Spot date |
|---------|-----------------------|---------|-------------|-------------|--------------|--|-----------------------|----|------|-----------------|-----|-------------------|
| | | | Pot | Rom | SACG | | | 1 | 2 | 2 | | 2C |
| | | | Pot | Rom | BSW | SV | Jar | 3 | 38 | 12 | | ML1-2C? |
| | | | Pot | Rom | 47 | misc | | 10 | 76 | 10 | (A) | Rom |
| | | | Slag | | | Small piece of vesicular glassy slag | | 1 | 1 | | | |
| | | | Abone | | | fragments | | 3 | 1 | | | |
| | | | Burnt stone | | | Small flint stones, affected by heat (discoloured, crazed) | | 5 | 10 | | | |
| F78 | Pit | 47 | Pot | Rom | 41 | Dish with groove below plain rim form B3 2.2 (Cam 40B) | B3 2.2 (Cam 40B) | 1 | 42 | 8 | | E2-E3/3C |
| | | | Pot | Rom | 47 | Includes rim – ?bowl with collar, similar to ?BB forms | | 2 | 54 | 8 | | Rom (2-3C?) |
| | | 51 | Burnt stone | | | Two stones, both appear affected by heat (discoloured) | | 2 | 100 | | | |
| L3 | Subsoil/ accumulation | 42b | Pot | Rom | BSW | Misc, including cordoned early Roman pot | | 5 | 56 | | | Rom (M1-E2C) |
| | | | Pot | Rom | 44 | | | 1 | 46 | | | M1-2C |
| | | | Pot | Rom | 47 | | | 3 | 22 | 4 | (A) | |
| | | | Pot | Rom | 47 | BB bead rim dish/bowl from in greyware (Cam 37B) | B 4 2.1/ 2.2 (Cam 37) | 1 | 14 | 8 | (A) | ML2-3C |
| | | | Pot | Rom | AA (58) | Rim from a salazon amphora in pale faintly greenish-buff fabric, note: slightly unusual outside of major towns/ military sites | D 7-11 | 1 | 130 | 18 | (A) | M1-E2C |
| | | | Pot | Rom | 27 (M) | mortarium | | 1 | 114 | | (A) | L1-E3C |
| | | | CBM | Rom | OR-F/MS | Imbrex | RI | 2 | 168 | | A | Rom |
| | | | CBM | p-med | OR-MS | Coarse feel, piece of post-medieval brick | | 1 | 22 | | (A) | p-med |
| | | | Pot | mod | 48D | Blue pained pattern creamware | | 1 | 20 | 8 | | L18-19/E20C |
| | | | Slag | | | Rounded (irregular) pat of ferrous slag material | | 1 | 166 | | | |
| L5 | Modern dump | 41b | CBM | Rom | OR-F/MS | Small regular tesserae cube, c 15-20mm sq | Tess | 1 | 12 | | | Rom |
| | | | Flint | preh | | End scraper, made on the distal end of either a snapped blade or a broken flake. | | 1 | 4 | | | Later prehistoric |
| | | | Burnt stone | | | | | 1 | 18 | | | |
| | | | Pot | Rom | AA (58) / 31 | Possibly an amphora sherd | | 1 | 22 | | A | |
| | | | Pot | Rom | BSW | | | 3 | 16 | | | Rom |
| | | | Pot | Rom | 47 | | | 1 | 3 | | | Rom |
| | | | Pot | Rom | 31 | | | 1 | 4 | | (A) | Rom |
| U/S | Unstratified | 46 | Pot | Rom | 47 | Includes sherd from lid-seated jar (form G5 / G7) | G5 / G7 | 2 | 22 | 5 | | 2-3C |
| | | | CBM | Med/ p-med | O-F/MS | Small piece of thin tile, almost without doubt peg-tile | PT | 1 | 14 | | | Med- p-med |
| | | | Burnt stone | | Flint /chalk | Small piece of burnt stone, flint/ chalk cortex | | 1 | 2 | | | |

Appendix 3 Animal bone list

| Context & finds no. | Total quantity | Species | Frag-ments | Bone | Butchery | Comments | Side |
|---------------------|----------------|---------------------|------------|--------------------------------|-------------------------------|--|-------|
| F19, 20 | 68 | <i>Bos</i> | 1 | scapula | | | left |
| | | <i>Bos</i> | 2 | scapula | | | right |
| | | Medium/large mammal | 1 | scapula | | | |
| | | <i>Bos</i> | 1 | metacarpal | | spiral fracture | |
| | | <i>Equus</i> | 2 | 1st phalanx | | | |
| | | <i>Bos</i> | 2 | horncore | Sawn or chopped | fragment | |
| | | <i>Sus</i> | 4 | mandible | | M3 in eruption | left |
| | | <i>Ovis</i> | 2 | mandible | | molar, prem, bone | |
| | | Large mammal | 1 | carpal/tarsal | | | |
| | | Medium mammal | 2 | mandible | | juvenile, no teeth, probably <i>ovis</i> | |
| | | <i>Sus</i> | 2 | ulna | | | |
| | | Medium/large mammal | 2 | cranial frags | | | |
| | | <i>Bos</i> | 1 | humerus | | | |
| | | <i>Ovis</i> | 1 | humerus | | | |
| | | Large mammal | 13 | axial | | | |
| | | Large mammal | 4 | appendicular | | | |
| | | Medium mammal | 2 | appendicular | | | |
| | | Large mammal | 7 | ribs | Cut marks x 1 | | |
| | | Medium/large mammal | 6 | ribs | Cut marks x 1, chop marks x 1 | | |
| | | Small/medium mammal | 3 | ribs | | | |
| | | Small mammal | 1 | ribs | | | |
| | | <i>Avis</i> | 8 | radius, humerus, ulna, sternum | | | |
| F19, 21 | 12 | <i>Bos</i> | 3 | scapula | | Probably from one bone | |
| | | Large mammal | 1 | rib | Chopped or sawn | | |
| | | Large mammal | 1 | vertebrae (thor) | Cut mark | | |
| | | Large mammal | 1 | vertebrae (axis) | | | |

| | | | | | | | |
|---------|---|---------------------|---|--------------|--------------------------------|--------------------|-------|
| | | Medium/large mammal | 2 | axial | | | |
| | | Large mammal | 1 | appendicular | | | |
| | | Medium mammal | 2 | axial | | | |
| | | Medium/large mammal | 1 | rib | | | |
| F19, 22 | 7 | <i>Bos</i> | 2 | scapula | Chop marks | | |
| | | <i>Bos</i> | 1 | metatarsal | | | right |
| | | <i>Bos</i> | 1 | astragalus | | Possible pathology | |
| | | Large mammal | 1 | appendicular | | | |
| | | Large mammal | 2 | rib | Chopped | | |
| F19, 25 | 1 | <i>Avis</i> | 1 | humerus | | | |
| F67, 41 | 1 | <i>Bos</i> | 1 | scapula | Sawn, other possible cut marks | | left |
| F73, 45 | 3 | <i>Bos</i> | 2 | mandible | | Including molar | |
| | | Medium mammal | 1 | axial | | Possibly vertebrae | |
| F73, 48 | 1 | Medium mammal | 1 | appendicular | | | |

Appendix 4 Small finds list

| SF | context | find no. | object type | description | no. | wt (g) | length mm | width mm | thickness mm | diameter mm | spot date |
|----|--|-------------|-------------|---|-----|--------|-----------|----------|--------------|-------------|--------------------|
| 1 | F22, Roman roundhouse posthole | 12 | Sheet | Four thin fragments of copper-alloy sheet, largest piece 27mm by 25mm by <1mm thick | 3 | 2 | 27 | 25 | <1 | | - |
| 2 | F19, Roman well with post-medieval/modern settling | 18 mid fill | Coin | Silver contemporary copy of a radiate ('barbarous radiate'), probably copying a coin of Victorinus (269-271), Virtus reverse, similar to RIC 78. Most of these copies were struck c 275-85 when there was a shortage of small change in Britain. Obverse: radiate bust right, bearded and draped IM C [...] INS PF AVG. Reverse: Virtus, standing facing, helmeted, head right, holding spear in right hand, resting left hand on shield, VIRTV AVG | 1 | 2 | | | 1 | 19 | Roman, 3rd century |
| 3 | F21, mid-late 2nd century drip-gully | 19 | Coin | Copper-alloy ?dupondius of Antoninus Pius, AD 138-161. Die axis: 11. If a radiate crown, likely to be RIC 659, AD 140-144. Obverse: bearded bust right, worn but probably radiate crown [ANT]ONINVS AVG PIVS PP [...] . Reverse: Very worn, figure standing left, probably holding caduceus, inscription illegible. | 1 | 12 | | | 3 | 26 | Roman, AD 138-161 |

| SF | context | find no. | object type | description | no. | wt (g) | length mm | width mm | thick-ness mm | diameter mm | spot date |
|----|--|---------------|------------------|---|-----|--------|-----------|----------|---------------|-------------|---|
| 4 | F19, Roman well with post-medieval/modern settling | 23 upper fill | Pin/needle shaft | Broken copper-alloy pin/needle shaft, tapering to a point, rest missing. | 1 | 1 | 49 | | | 3.5 | Roman |
| 5 | F21, mid-late 2nd century drip-gully | 32 | Fragment | Small fragment of an unidentified copper alloy lump, possibly a melted lump | 1 | 1 | 26 | 15 | 2 | | Roman |
| 6 | F19, Roman well with post-medieval/modern settling | 25 mid fill | Disc | Small silver disc, no surface decoration visible. | 1 | <1 | | | 1 | 9 | - |
| 7 | F19, Roman well with post-medieval/modern settling | 20 upper fill | Fragments | Two small fragments of sheet copper-alloy sheet. | 2 | <1 | 9 | 5 | 1 | | - |
| 8 | F19, Roman well with post-medieval/modern settling | 8 upper fill | Fragments | Two small fragments of sheet copper-alloy sheet. | 1 | <1 | 11 | 9 | <1 | | - |
| 9 | F17, Roman posthole | 7 | Object | Iron double-spiked loop (a structural fitting), made by bending a bar with spiked ends to form a loop with parallel arms, for examples see Manning 1985 R34-R47, p130 and plate 61 | 1 | 48 | 80 | 25 | | | Roman |
| 10 | L2, modern sub-base | 45 | Coin | Copper-alloy dupondius, possibly also of Antoninus Pius, AD 138-161, bust is very similar to SF3. Oval rather than round, 23-26mm. Die axis: 1. Obverse: radiate, bearded, bust right [ANT]ONINVS[...]. Reverse: Very worn, figure standing left, probably holding caduceus, inscription illegible but SC just about visible either side of figure. | 1 | 8 | | | 2 | 23-26 | Roman, 2nd century, possibly AD 138-161 |

Appendix 5 Environmental results

| Sample | Finds number | Feature number | Description | Bulk volume processed (L) | Flot volume (ml) | Charred grains | | | Charred wood >4mmØ | Charred wood <4mmØ | Dried waterlogged seeds | | | Modern root/rhizomes | uncharred small mammal bone | uncharred small mammal/reptile bone fragment | Terrestrial mollusca | Magnetic fragments | Details -main and significant taxa |
|--------|--------------|----------------|----------------------------|---------------------------|------------------|----------------|---|---|--------------------|--------------------|-------------------------|---|---|----------------------|-----------------------------|--|----------------------|--------------------|--|
| | | | | | | a | d | p | a | a | a | d | p | a | a | a | a | | |
| 1 | 25 | F19 | Roman well | 40 | 5 | - | - | - | - | 3 | 3 | 1 | 3 | 1 | - | - | - | 1 | uncharred seeds – mostly fat hen and some blackberry/raspberry |
| 2 | 28 | F32 | Roman pit/ditch | 40 | 20 | 1 | 1 | 2 | 1 | 2 | 2 | 1 | 3 | 1 | - | - | 1 | - | 3 charred wheat grains and 1 barley, uncharred seeds – fat hen and blackberry/ raspberry |
| 3 | 39 | F21 | Sx4, Roman drip-gully | 40 | 25 | 1 | 1 | 2 | 2 | 3 | 2 | 1 | 3 | 2 | 1 | - | - | - | 2 charred wheat grains, uncharred seeds – mostly fat hen and some blackberry/ raspberry |
| 4 | 40 | F21 | Sx3, Roman drip-gully | 40 | 75 | - | - | - | 1 | 3 | - | - | - | 1 | - | - | - | 2 | - |
| 5 | 48 | F73 | Medieval/post-medieval pit | 20 | 5 | - | - | - | 1 | 3 | 1 | 1 | 3 | 3 | - | 1 | - | - | uncharred seeds – fat hen |
| 6 | 49 | F67 | Roman pit | 10 | 5 | 1 | 1 | 2 | - | 2 | 3 | 1 | 3 | 2 | - | - | - | - | 1 charred possible spelt grain, uncharred seeds – mostly fat hen, some elderberry |
| 7 | 50 | F70 | Roman pit | 10 | 5 | 1 | 1 | 2 | 1 | 2 | 1 | 1 | 3 | 3 | - | - | - | - | 1 charred wheat type grain, uncharred seeds – blackberry/raspberry and elderberry |
| 8 | 51 | F78 | Roman pit | 10 | 5 | - | - | - | - | 1 | 1 | 1 | 3 | 3 | - | - | - | - | uncharred seeds of fat hen, blackberry/ raspberry and black nightshade |

Key: a = abundance [1 = occasional 1-10; 2 = moderate 11-100; and 3 = abundant >100]

d = diversity [1 = low 1-4 taxa types; 2 = moderate 5-10; 3 = high]

p = preservation [1 = poor (family level only); 2 = moderate (genus); 3 = good (species identification possible)]

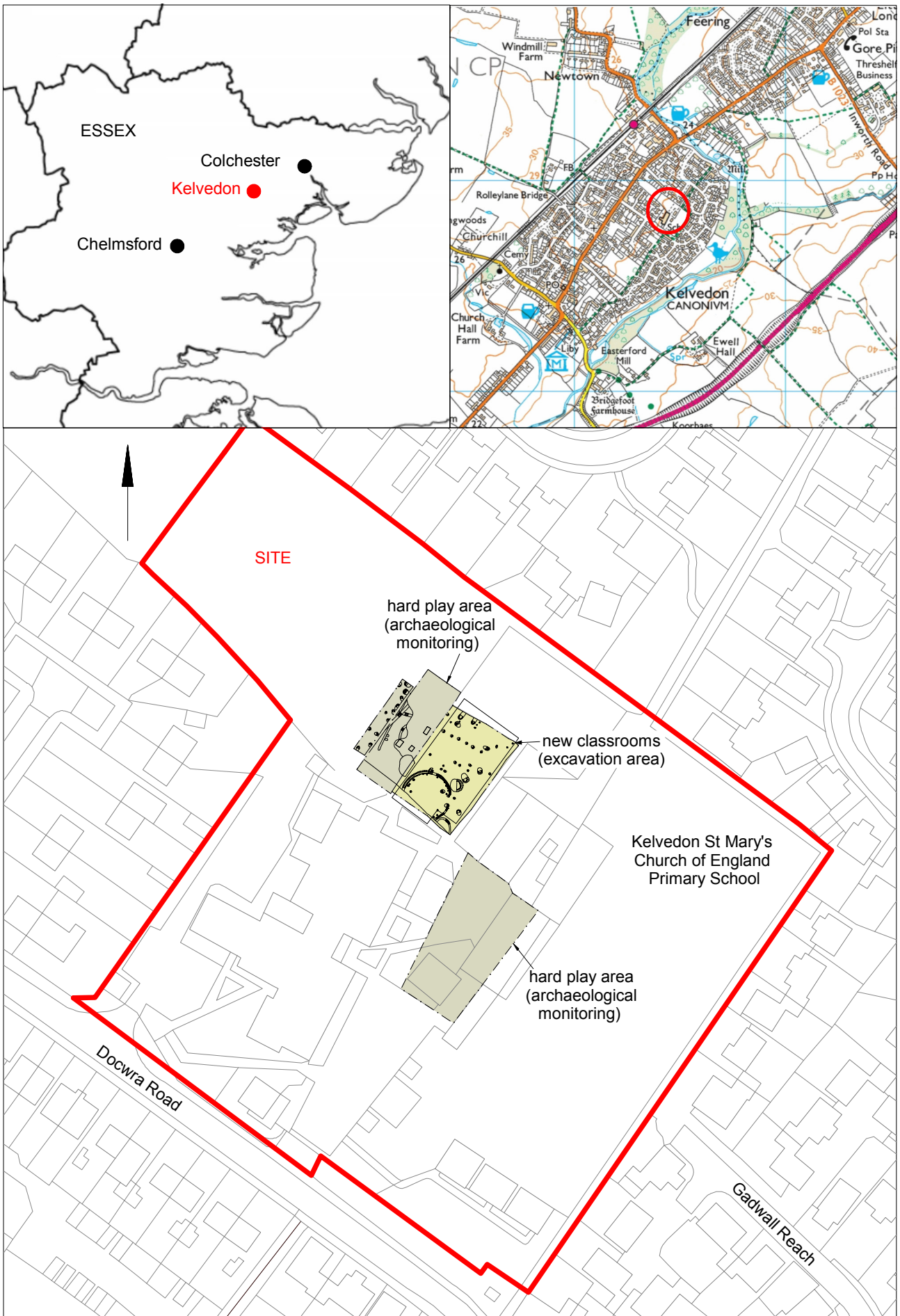

Fig 1 Site location

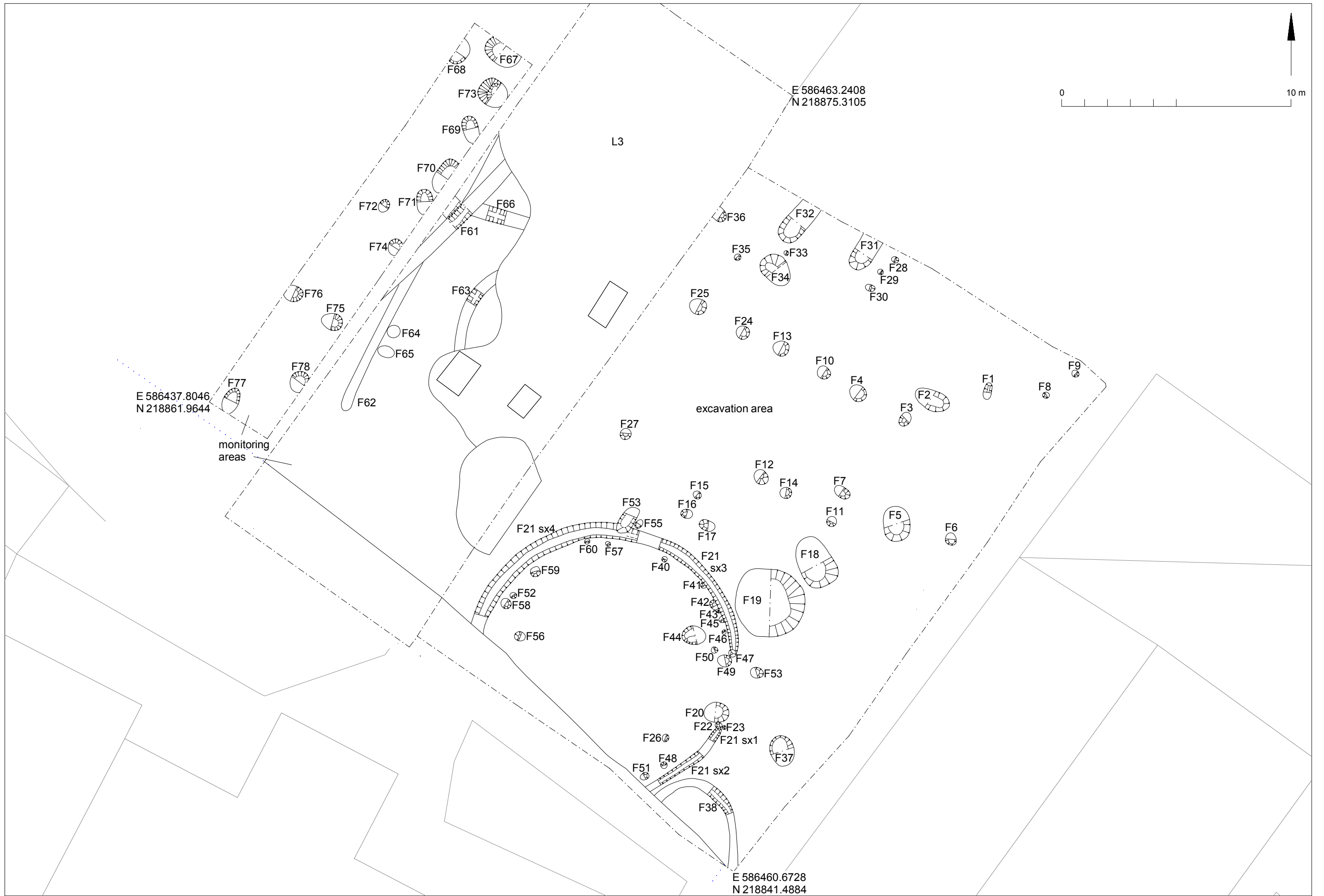

Fig 2 Results of excavation and monitoring

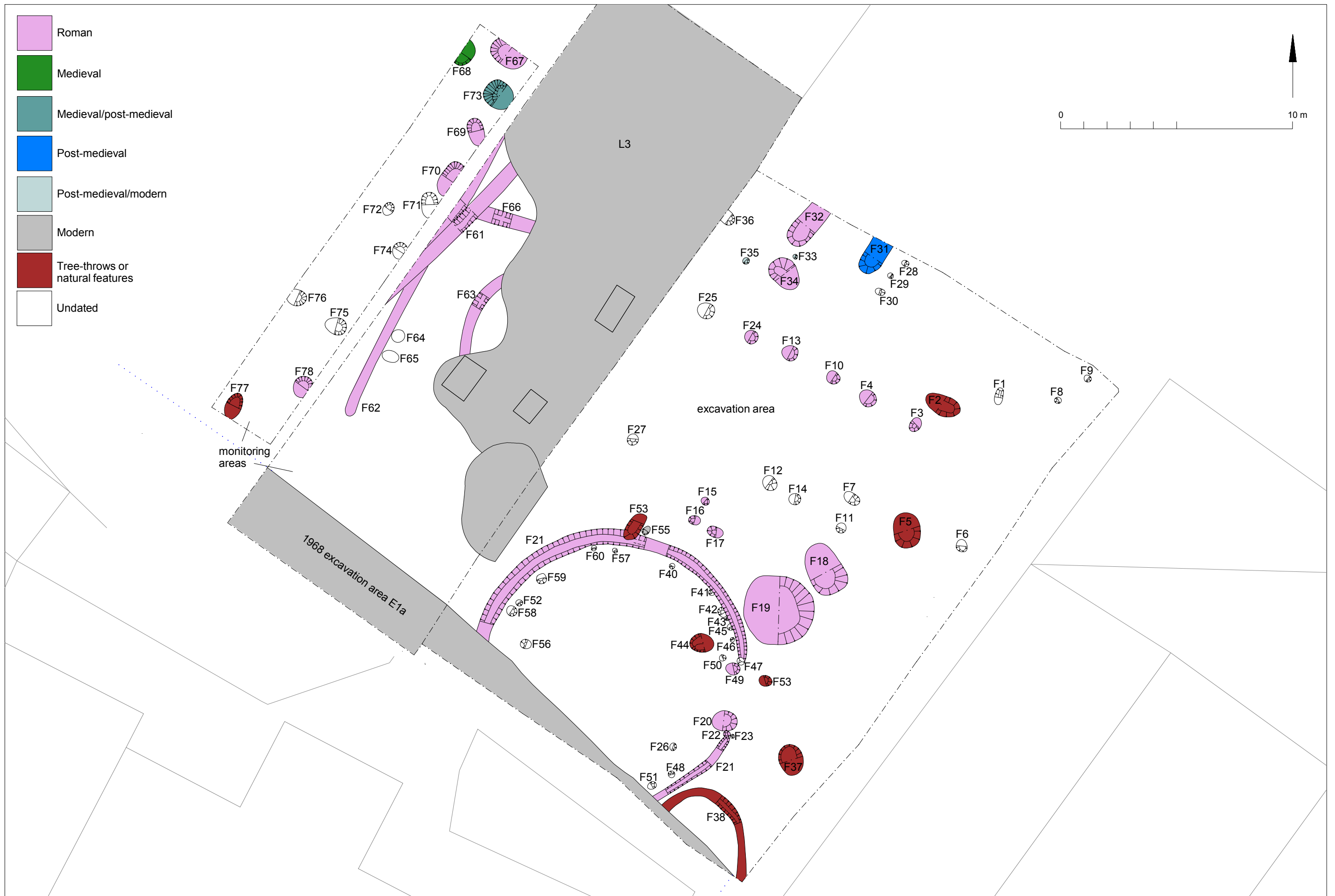

Fig 3 Phased results

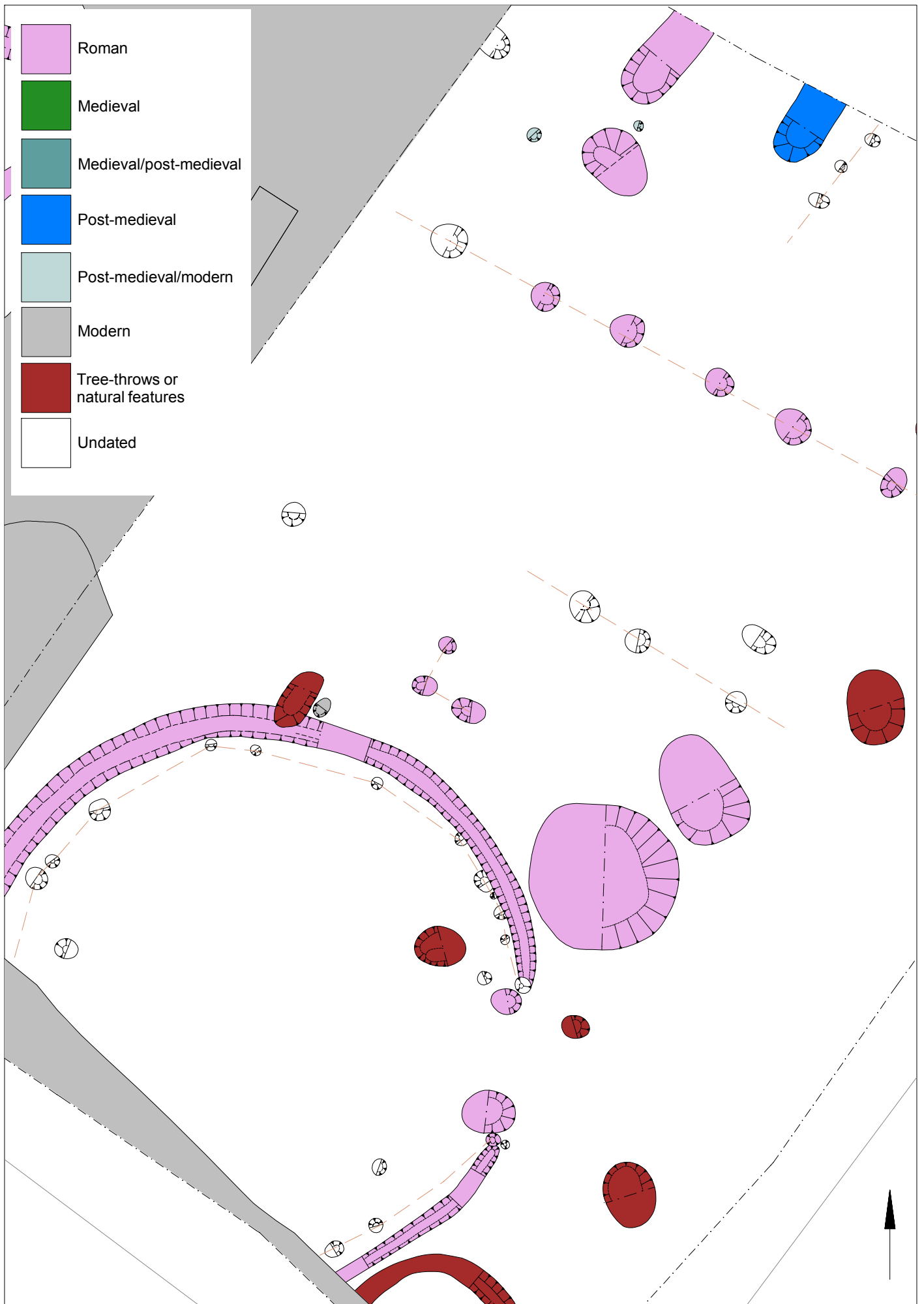

Fig 4 Close-up of roundhouse and post-structures

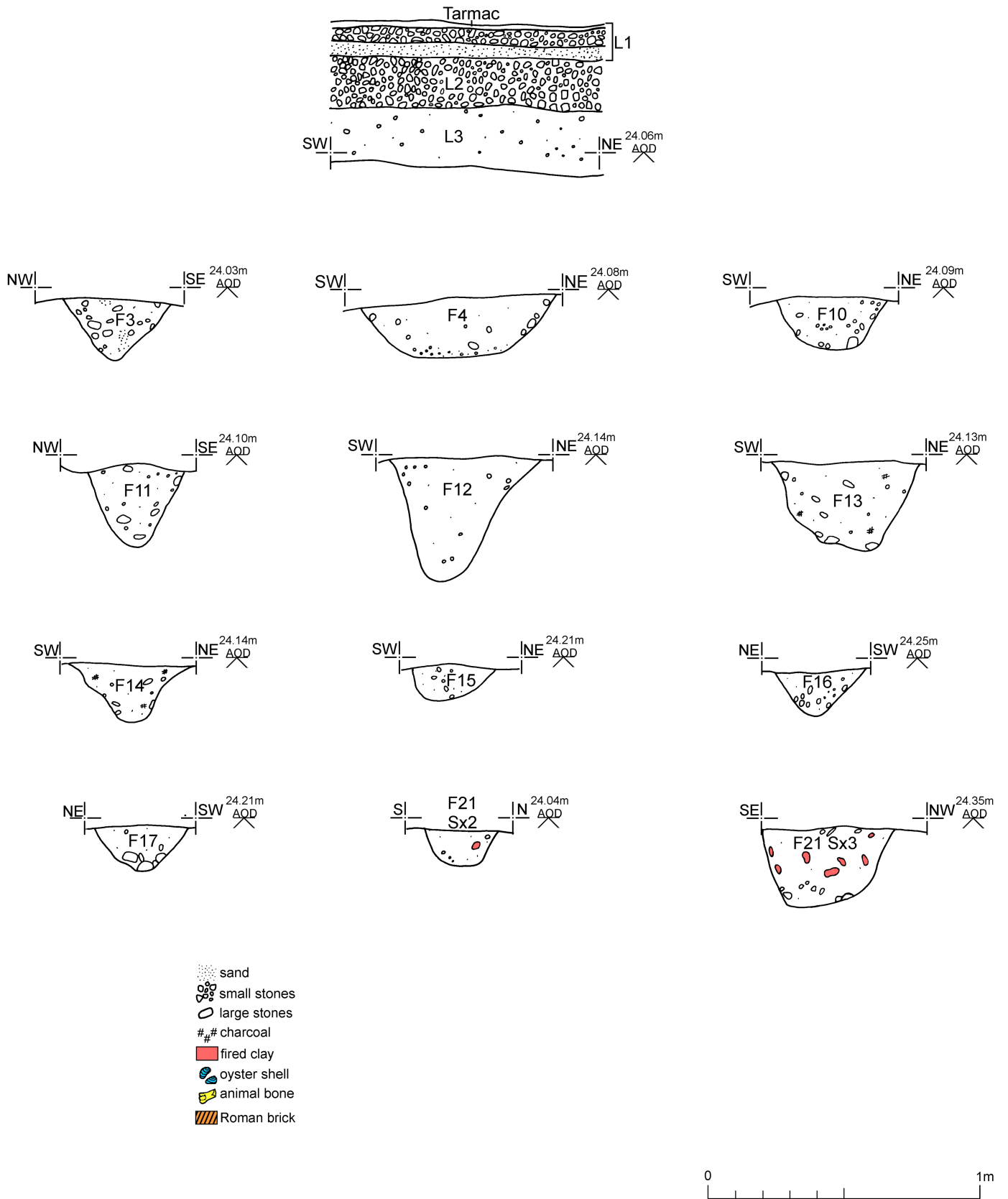

Fig 5 Representative and feature sections

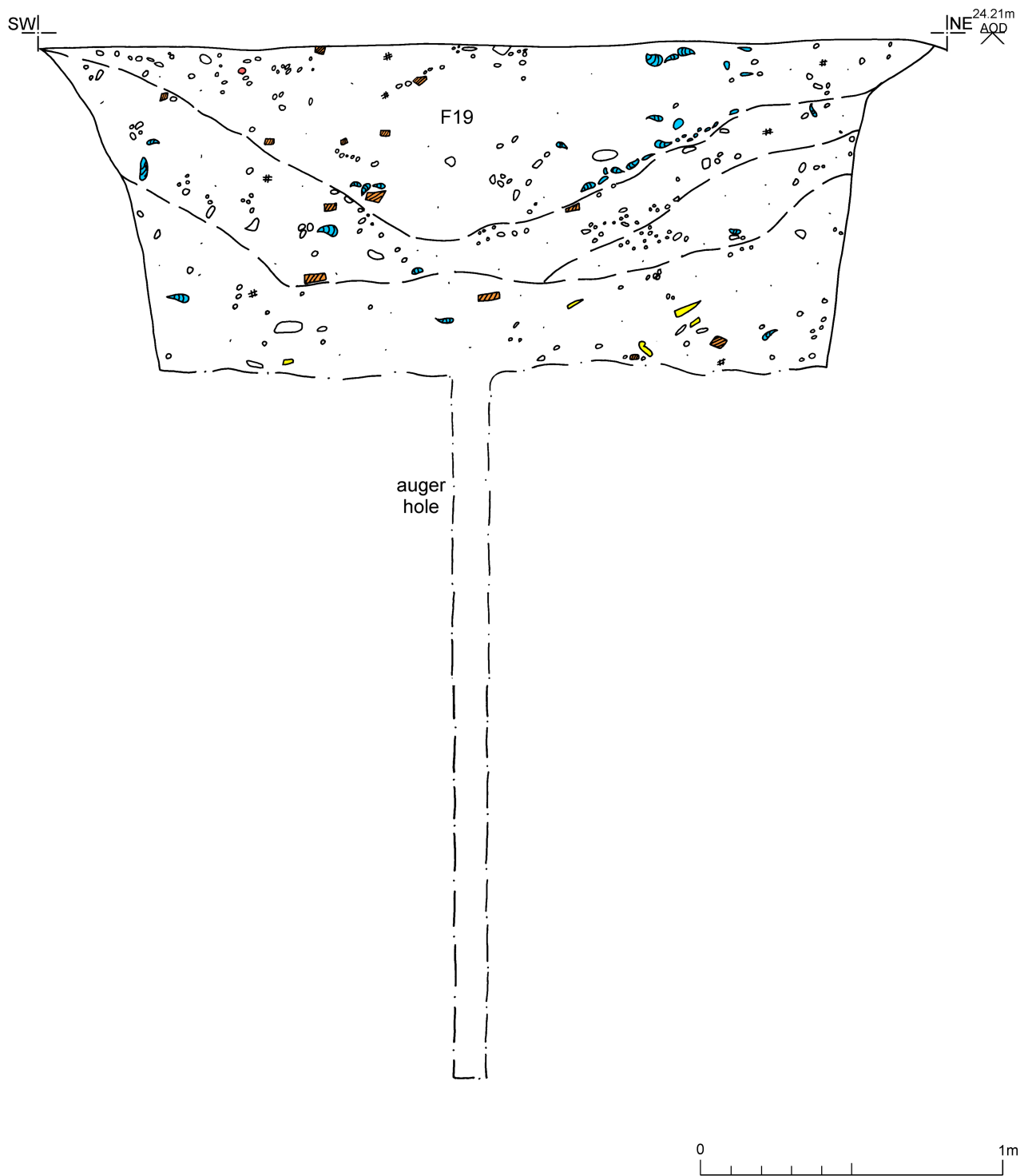

Fig 6 Feature section

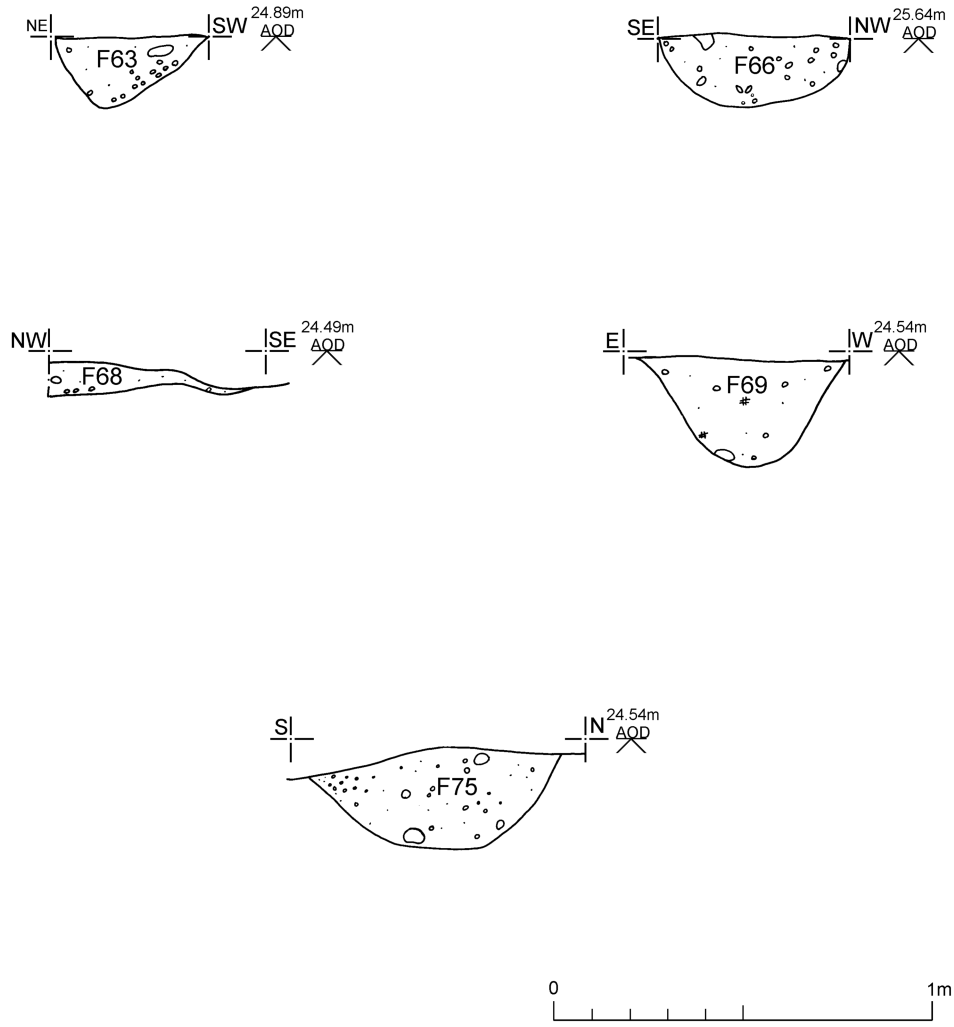

Fig 7 Feature sections

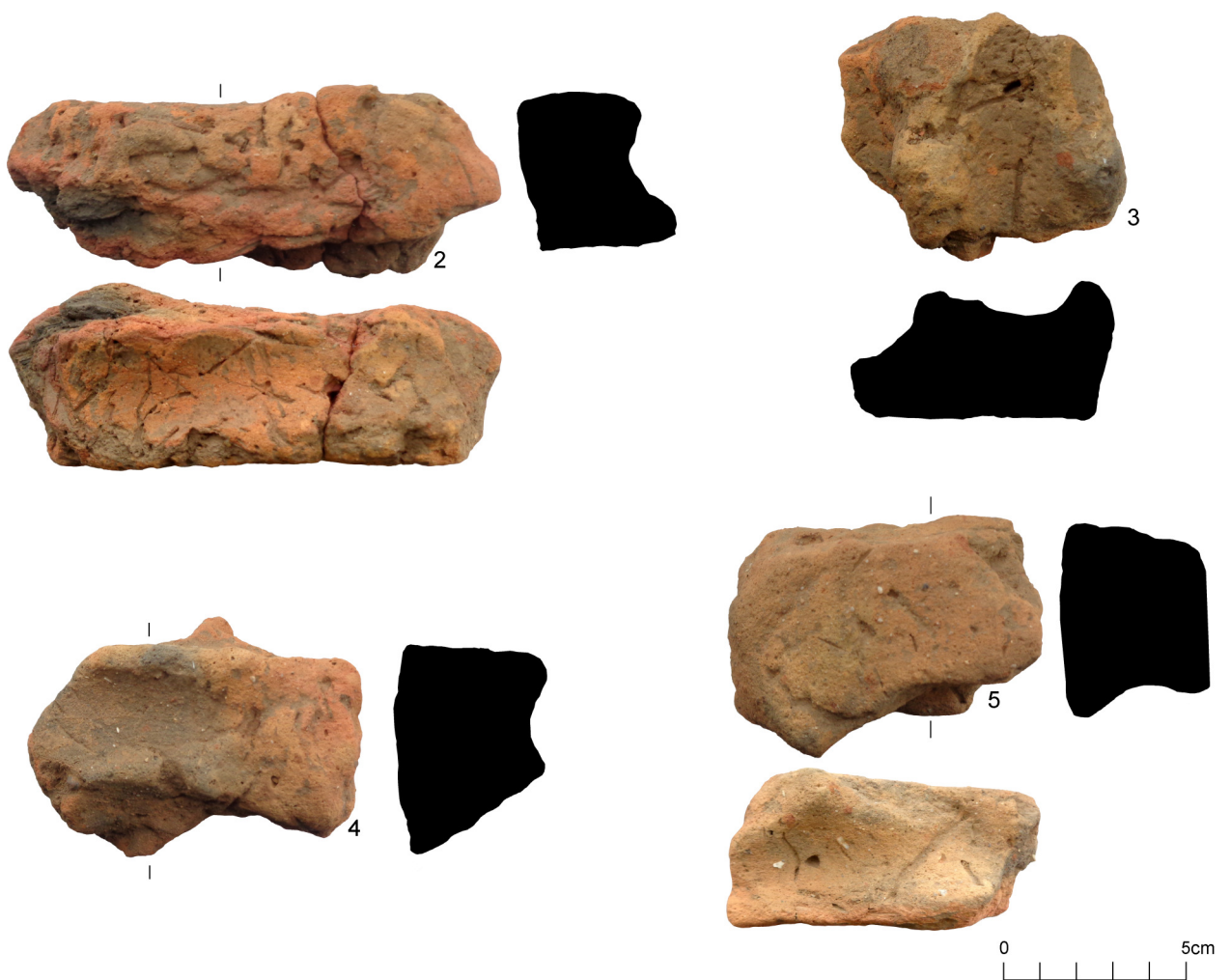
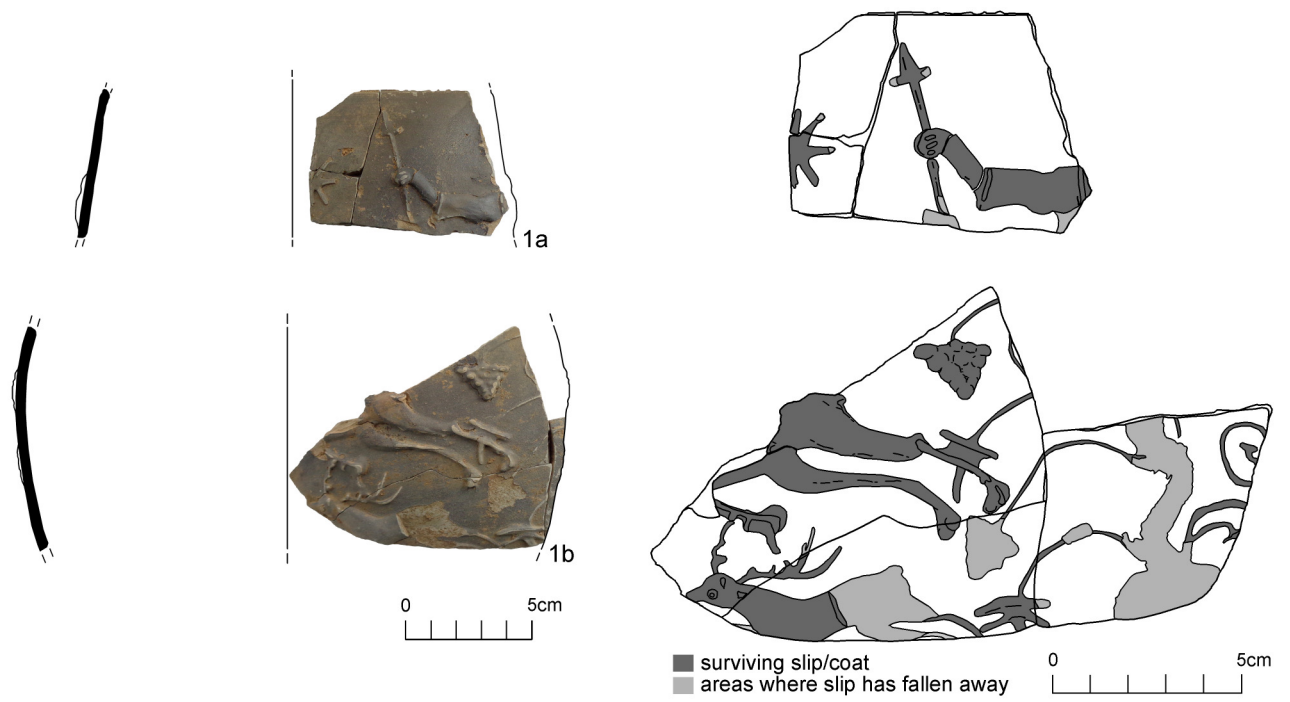
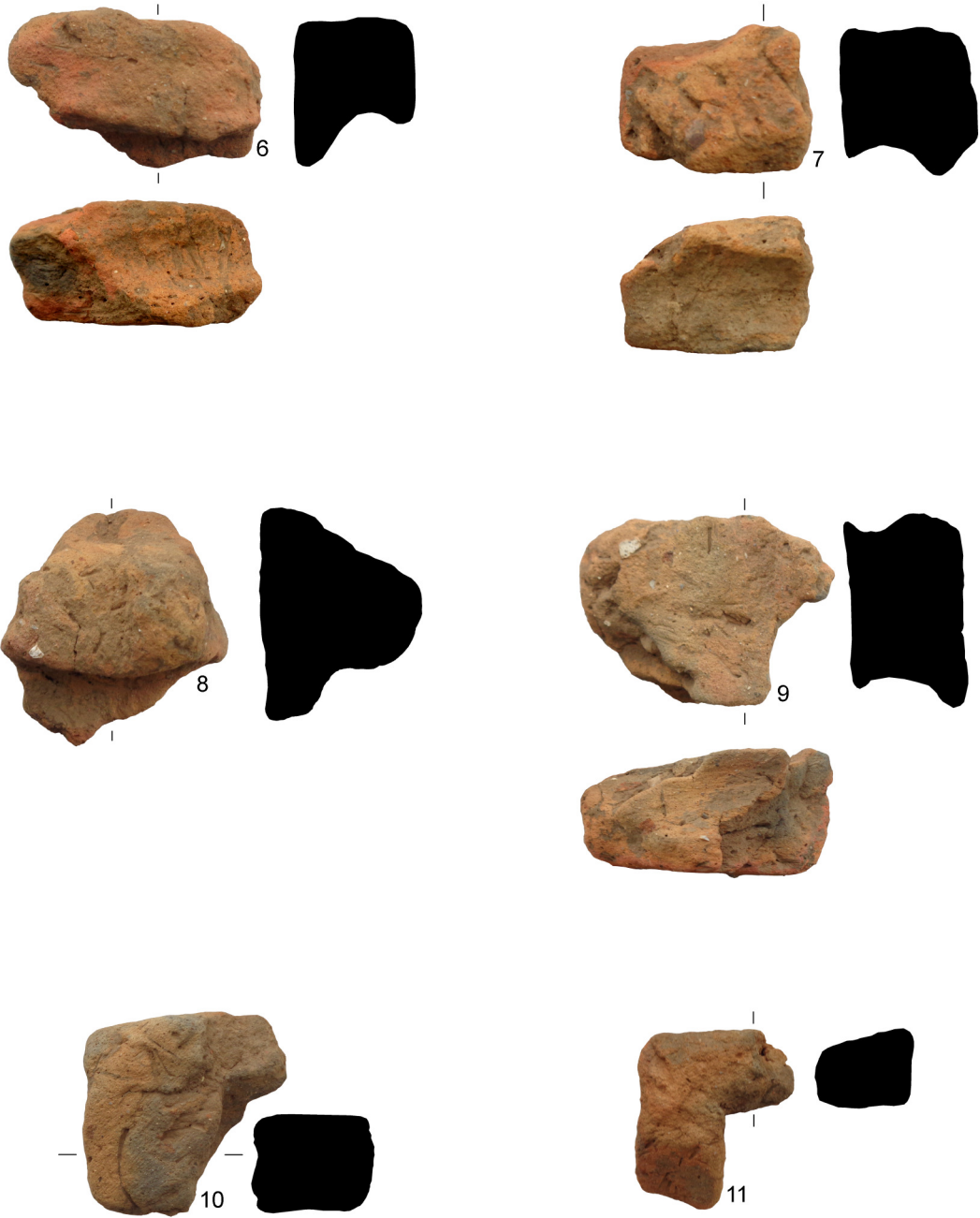

Fig 8 Roman barbotine pot (1) and fired clay (2-5).



0 5cm

Fig 9 Fired clay.

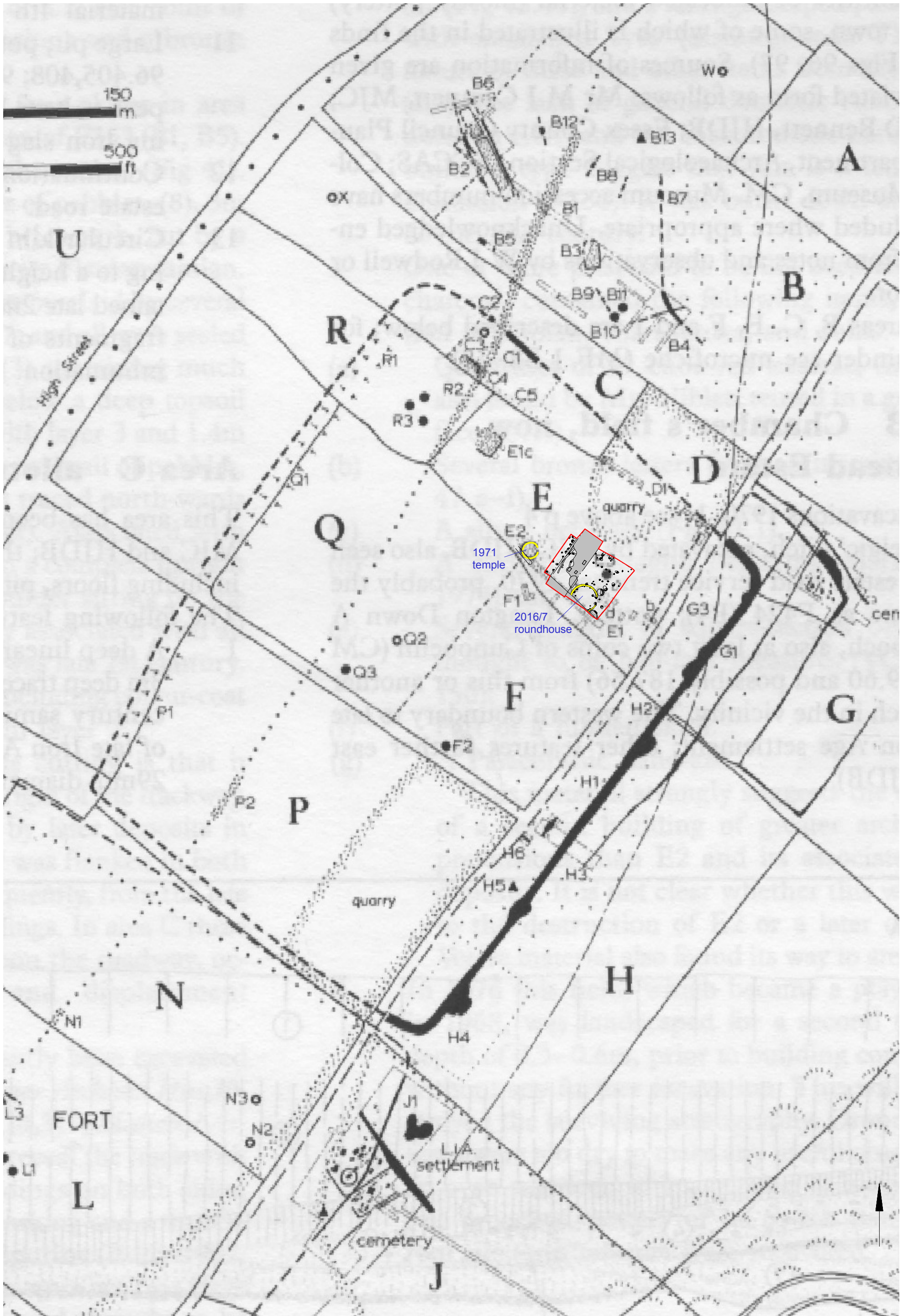

Fig 10 Site in relation to previous archaeological work (taken from Rodwell 1988, Fig 40).

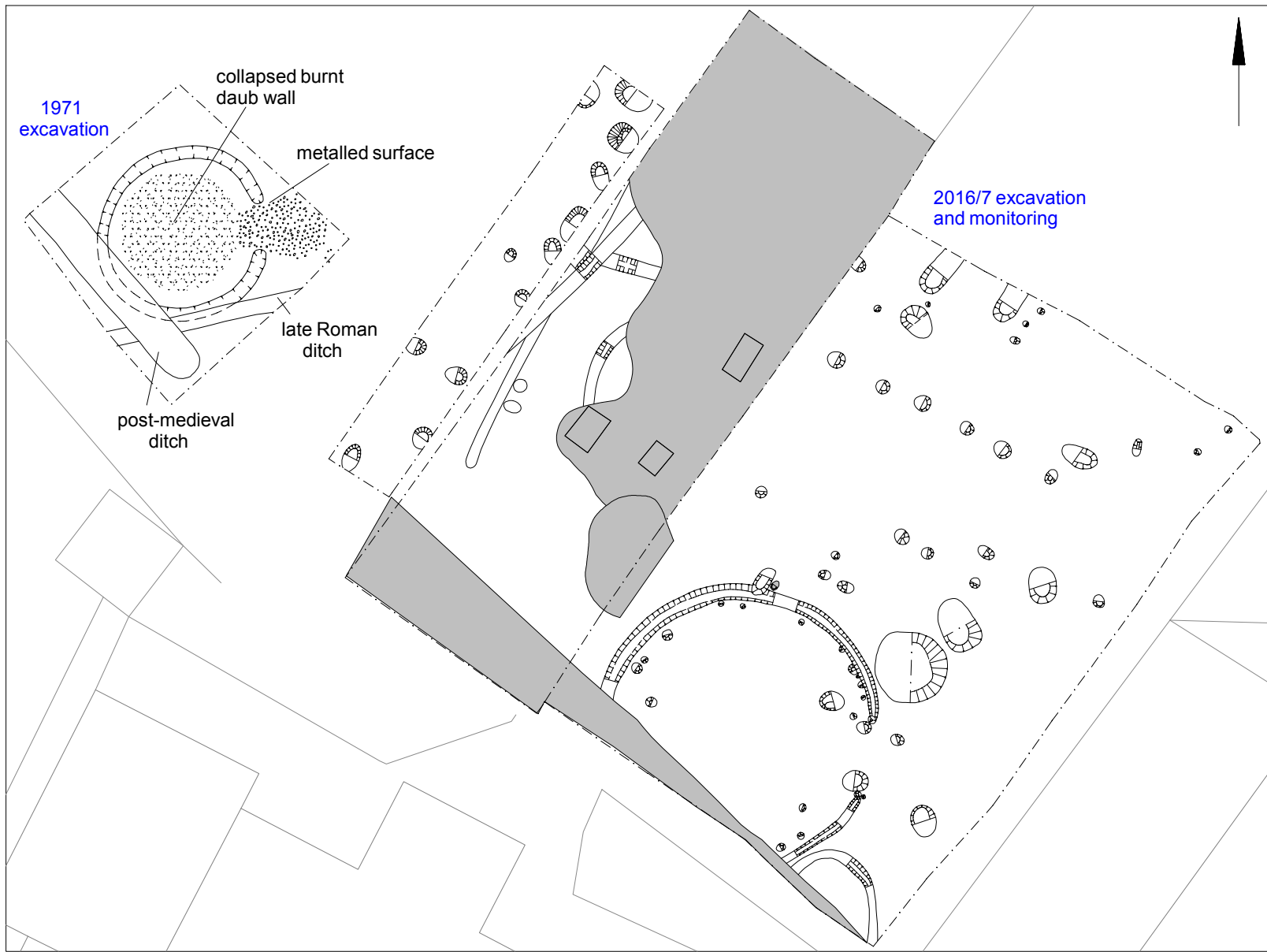
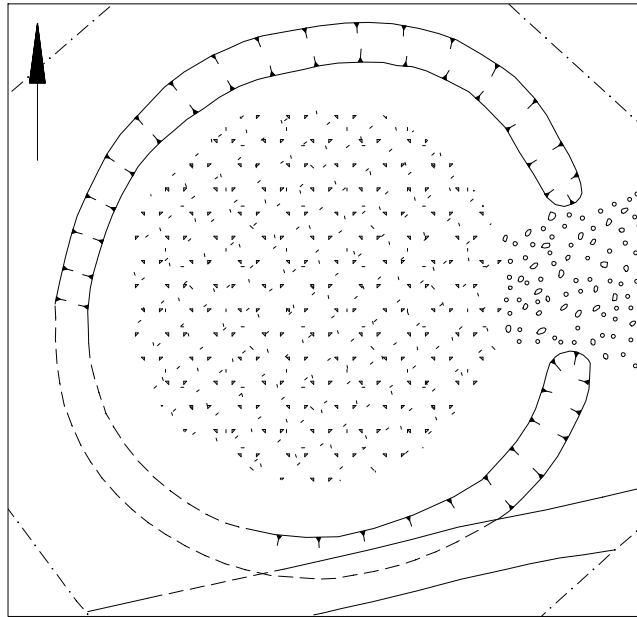
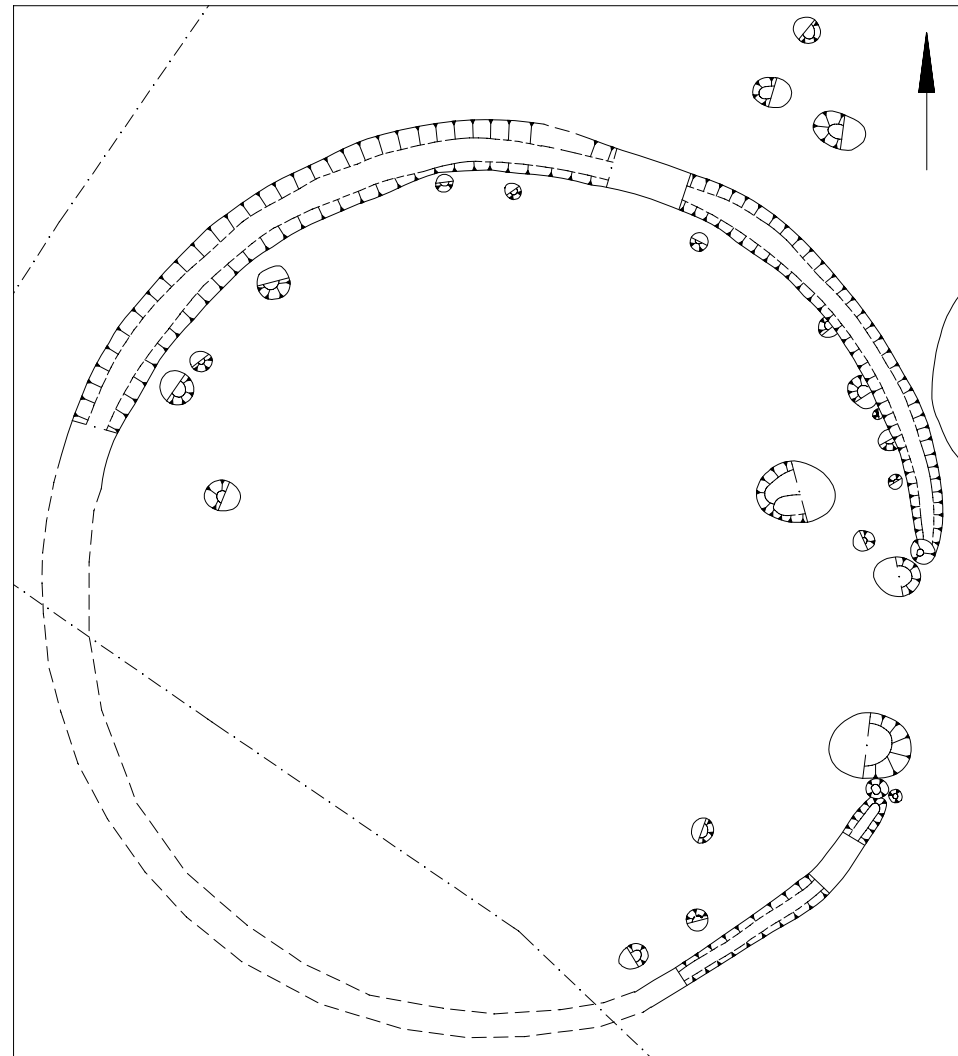

Fig 11 2016/7 results in relation to the 1971 excavations



1971 excavation



2016/7 excavation

Fig 12 Comparison of 1971 and 2016/7 round structures
(only Roman features shown)



OASIS DATA COLLECTION FORM: England

[List of Projects](#) | [Manage Projects](#) | [Search Projects](#) | [New project](#) | [Change your details](#) | [HER coverage](#) | [Change country](#) | [Log out](#)

[Printable version](#)

OASIS ID: colchest3-256817

Project details

| | |
|--|--|
| Project name | Archaeological excavation and monitoring on land at St Mary's Primary School, Docwra Road, Kelvedon, Essex, CO5 9DS |
| Short description of the project | An archaeological excavation and monitoring was carried out at St Mary's Primary School, Docwra Road, Kelvedon in advance of the construction of a new classroom and playground. Located within the Roman settlement at Kelvedon, previous archaeological investigations on the development site had revealed a round Roman temple. This current archaeological excavation revealed a Roman roundhouse consisting of nineteen postholes with an external drip-gully. The gully enclosed an area of approximately 12m in diameter with the roundhouse structure measuring 10m diameter. Dating evidence from the roundhouse would suggest that it fell out of use sometime in the mid to late 2nd century. Adjacent to, and probably contemporary with, the roundhouse was a deep well. Parallel lines of postholes nearby are probably fence-lines or fenced-enclosures, although there is a possibility that they may have formed a rectangular structure. Subsequent monitoring revealed four short lengths of Roman ditch, one of which is curved and might possibly be part of drip-gully or wall-trench for another round structure, and several Roman pits. Post-Roman features consisted of a medieval pit, a post-medieval pit/ditch and two postholes. Seven undated pits, five tree-throws and a natural feature were also recorded. |
| Project dates | Start: 18-08-2016 End: 19-07-2017 |
| Previous/future work | Yes / Not known |
| Any associated project reference codes | 16/07e - Contracting Unit No. |
| Any associated project reference codes | 16/00447/FUL - Planning Application No. |
| Any associated project reference codes | KL39 - HER event no. |
| Type of project | Recording project |
| Site status | None |
| Current Land use | Community Service 1 - Community Buildings |
| Monument type | ROUNDHOUSE Roman |
| Monument type | POSTHOLES Roman |
| Monument type | DRIP-GULLY Roman |
| Monument type | PITS Roman |
| Monument type | DITCHES Roman |
| Monument type | WELL Roman |
| Significant Finds | POTTERY Roman |
| Significant Finds | CERAMIC BUILDING MATERIAL Roman |
| Significant Finds | FIRE CLAY Roman |
| Significant Finds | COINS Roman |
| Significant Finds | POTTERY Medieval |
| Significant Finds | POTTERY Post Medieval |
| Significant Finds | ANIMAL BONE Post Medieval |
| Significant Finds | POTTERY Modern |
| Significant Finds | ANIMAL BONE Modern |
| Investigation type | "Watching Brief", "Open-area excavation" |
| Prompt | Planning condition |

Project location

| | |
|-------------------|--|
| Country | England |
| Site location | ESSEX BRAINTREE KELVEDON St Mary's Primary School, Docwra Road |
| Postcode | CO5 9DS |
| Study area | 1.89 Hectares |
| Site coordinates | TL 86446 18857 51.836640873124 0.706534513385 51 50 11 N 000 42 23 E Point |
| Height OD / Depth | Min: 23.95m Max: 24.83m |

Project creators

| | |
|---------------------------|---------------------------------|
| Name of Organisation | Colchester Archaeological Trust |
| Project brief originator | HEM Team Officer, ECC |
| Project design originator | Laura Pooley |
| Project director/manager | Chris Lister |

Project supervisor Ben Holloway
Type of sponsor/funding body Developer

Project archives

Physical Archive recipient Braintree Museum
Physical Archive ID KL39
Physical Contents "Animal Bones","Ceramics","Metal","Worked stone/lithics"
Digital Archive recipient Braintree Museum
Digital Archive ID KL39
Digital Contents "Stratigraphic","Survey"
Digital Media available "Images raster / digital photography","Survey"
Paper Archive recipient Braintree Museum
Paper Archive ID KL39
Paper Contents "Stratigraphic","Survey"
Paper Media available "Context sheet","Miscellaneous Material","Photograph","Plan","Report","Section"

Project bibliography 1

Publication type Grey literature (unpublished document/manuscript)
Title A Roman roundhouse: archaeological excavation and monitoring on land at St Mary's Primary School, Docwra Road, Kelvedon, Essex, CO5 9DS. August 2016-July 2017
Author(s)/Editor(s) Pooley, L.
Other bibliographic details CAT Report 1007
Date 2017
Issuer or publisher Colchester Archaeological Trust
Place of issue or publication Colchester
Description A4 ringbound loose leaf
URL <http://cat.essex.ac.uk/all-reports.html>

Entered by Laura Pooley (lp@catuk.org)
Entered on 5 October 2017