

**Archaeological trial trenching at the
Arena Leisure Centre,
Circular Road East,
Colchester, Essex
Phase 1a: pre-determination trenching
April-May 2015**



**Report prepared
by Mark Baister
with contributions from Stephen Benfield,
Julie Curl and Robert Masefield**

**contracted by RPS
on behalf of
RMPA**

CAT project ref: 15/02f
NGR: TL 997 244
Colchester Museum accession code: 2015.43



Colchester Archaeological Trust
Roman Circus House,
Roman Circus Walk,
Colchester,
Essex CO2 7GZ

Tel: 01206 501785

E-mail: archaeologists@catuk.org

CAT Report 843
June 2015

Contents

1. Summary	1
2. Introduction	1
3. Archaeological background	1
4. Aim	3
5. Trial-trenching methodology and results	3
6. Finds	12
7. Discussion	15
8. Acknowledgements	16
9. References	16
10. Abbreviations and glossary	17
11. Contents of the archive	17
12. Archive deposition	17

Figures after p 17

Appendices (Finds, WSI and Oasis Form)

List of Figures

- Fig. 1 Site location.
- Fig. 2 Arena site shown in context with nearby excavations.
- Fig. 3 Evaluation results.
- Fig. 4 Evaluation results with extrapolated ditches (and modern services).
- Fig. 5 Detailed trench plans.
- Fig. 6 Evaluation results with assumed graves highlighted.
- Fig. 7 Burial plan and section (F2).
- Fig. 8 Burial plan and section (F13) and plan of stone spread (F10).
- Fig. 9 Feature sections.
- Fig. 10 Feature sections.
- Fig. 11 Feature sections.
- Fig. 12 Representative trench sections.
- Fig. 13 Representative trench sections.

List of Plates

- | | |
|-----------|--|
| Cover | Site view, facing north-west. |
| Plate I | T1 long shot. Shot taken facing south-west. |
| Plate II | F43 and F44 in T2. Shot taken facing north. |
| Plate III | T4. Shot taken facing north. |
| Plate IV | T9 long shot. Shot taken facing south-east. |
| Plate V | F2 completely excavated. Copper alloy neck ring (SF1) shown in situ to right of frame. Shot taken facing north-east. |

1. Summary

Phase 1a of the evaluation saw eleven trenches being excavated across the site of the Arena Leisure Centre, prior to its closure and subsequent demolition. Numerous features of archaeological interest were encountered, including eleven Roman assumed inhumations and a collection of Roman field boundaries and pits. Also identified was a selection of post-medieval pits and ditches. Of particular interest is the recovery of a copper-alloy neck ring and two associated human molars from an assumed inhumation in ditch F2.

2. Introduction (Fig 1)

This is the report on Phase 1a of trial-trenching carried out by Colchester Archaeological Trust (CAT) at the Arena Leisure Centre, Circular Road East, Colchester (TL 997 244), on the 29th-30th April and the 11th-12th May, 2015. The work was commissioned by RPS Group Plc on behalf of RMPA. The overall project was managed for RMPA by Fenn Wright. The trenching was required prior to the determination of an outline planning application submitted to CBC and Historic England. The proposed development of the site comprises the demolition of the current buildings and the construction of about 100 residential units and commercial developments with associated access, services and landscaping.

Phase 1a of the evaluation consisted of 362 square metres of trenching (201m in length and 1.8m in width) across accessible areas of the site. Inherently the trenching was constrained by the current site use and as such the final total area of the evaluation in this stage is some 70m square metres less than that specified in the WSI (432m square metres). This is discussed in more detail on a trench by trench basis below.

Phase 1b of the evaluation will be undertaken when (if) planning consent is given and will be the subject of a separate report. Phase 1b will consist of trial-trenching across the footprint of the Roman circus to the north and within the footprint of the current Arena building following demolition.

Work in Phase 1a proceeded in accordance with a WSI prepared by Rob Masefield of RPS (2015; provided as an Appendix to this report).

In addition to the WSI, all fieldwork and reporting was done in accordance with local and national standards as detailed in CAT 2014, ClfA 2008a, ClfA 2008b, MoRPHE, EAA 8, EAA 14, and EAA 24.

3. Archaeological background (Fig 2)

The area surrounding the Arena site has been the subject of several large-scale archaeological investigations in the past, the results of which are briefly summarised below. More details can be found in CAT Reports 97, 412 and 424.

Neolithic and Bronze Age

Neolithic and Bronze Age features (largely pits), have been uncovered during excavations in areas C1 and C2 to the north and east of the Arena site respectively (Fig 2). A Bronze Age pit containing probable Beaker sherds was identified during the excavation of Circular Road North in 2007. No evidence of Neolithic or Bronze Age activity has been found at the Arena site itself.

Iron Age and the Oppidum

The Arena site falls within the eastern area of the Late Iron Age oppidum of Camulodunum (CAT Report 97). The only above-ground traces of this oppidum are the linear banks and ditches of its surrounding defensive dyke system. The closest of these is located some 0.6km away from the Arena site, in the south-east corner of the residential development of the former Hydrabad and Meeanee Barracks (GAL Area A1, CAT Report 628 – forthcoming).

Within the oppidum are two known areas of concentrated activity: Gosbecks Farm, the site of a late Iron Age and Roman farmstead, is 3.5km south-west of the Arena. Sheepen, an industrial and trading centre, is 1.5km to the north-west.

Iron Age activity immediately around the Arena site is limited. Three minor ditches in Area C1 are undated but pre-date the Roman circus and may belong an Iron Age or early Roman field system. Two mid-to-late Iron Age parallel driveway ditches and some related pitting were identified in Area J in 2004 and found to extend into the Circular Road North excavation and the Athletics track car park excavations in 2007.

Roman

The plateau of flat ground c400m south of the Roman town, which includes the northern extent of the Arena site, contains internationally important Roman archaeology in the form of a stone-built monumental Roman circus discovered in 2004. The circus is currently unique in Britain and has been investigated over multiple archaeological sites, including Areas C1, C2 and J, as well as the Circular Road North and Napier Road excavations (Fig 2). Smaller-scale research excavations have taken place identifying a section of the starting gates (in 2007), and an excavation in 2013 outside Roman circus House exposed a section of the northern cavea wall, which has been covered with a viewing platform and is now on display.

The circus was approximately 450m in length and 70m wide with a central barrier (spina). Elements identified to date include the stands, known as the 'cavea', with internal and external walls, entrances on the north and south caveas, a racetrack dirt surface, a segment of the semi-circular end of the circus, eight starting gates, and elements of the 'spina' including fragments of a turning post at the western end. In Areas C1 and C2, a metalled trackway was identified around the circus.

The circus appears to have been pulled down in the late Roman period, with rubble spreads to the exterior of the outer wall observed in excavations.

Apart from the circus, the only other archaeology previously encountered within the Arena site is a Roman pottery kiln discovered by a construction team in 1946 whilst excavating the foundation for the current building (Hull, 1958, 249). It was plotted as being at the south-east side of the main building (Fig 1 shows the approximate location of the kiln but may not be accurate).

Immediately surrounding the Arena site, numerous Roman burials have been found, within the Area C2, Napier Road, Circular Road North, Napier Road carpark and Abbey Field excavations. Slightly further afield, more burials were uncovered in Area J, to the north-west, and Area E, to the south-east. In total, more than 150 Roman burials have been recovered from the area immediately surrounding the Arena, with 68 coming specifically from the closest site, Area C2. Eleven of these burials were ring-gully defined former barrows, containing cremations. This style of burial suggests both possible Germanic and military associations.

As well as those from recent large-scale excavations, at least 28 Roman cremations were uncovered when the north of Abbey field was being levelled for sports pitches in 1925 (Hull 1958, 255). It was therefore likely that burial activity would be uncovered during the 2015 evaluation. However, the presence of a Roman kiln would be atypical on a cemetery site, and could suggest a distinct separation of activities. Alternatively there could be a chronological difference in the use of this space (e.g. the kiln pre-dated the cemetery).

The area to the south of the Arena is part of the rural hinterland south of the Roman town and the circus. To the south-east of the Arena, a small farmstead/villa lies within the playing fields of a new primary school. When CAT excavated the footprint of the school in 2013 (Area E on Fig 2), a series of field boundaries and a large Roman quarry were uncovered, as well as several cremation burials, including a bustum (CAT Report 778).

Saxon

Early Saxon burials were uncovered in the Area A1 excavations to the east of Mersea Road, some 300m east of the Arena site. About 70 inhumations were found, three of which contained Anglo-Saxon weapons and were associated with ring-ditches of probable barrows – similar in form to the late 3rd-century Roman examples at Area C2, Napier Road and Circular Road North. The remaining inhumations in Area A1 were not securely dated, although a late Roman to Saxon date seems likely (CAT Report 628 - forthcoming).

Medieval

The only medieval archaeology located immediately within the vicinity of the Arena site consists of extensive robber trenches above the circus foundations. The circus foundations were evidentially systematically robbed during the medieval period, with greensand (perhaps from the circus) still observable in the remains of St John's Abbey wall to the north. As well as the robber trenches themselves, spreads of mortar and demolitions layers appear to be associated with this activity.

Post-medieval

The Parliamentary siege of Colchester in 1648 involved the construction of several large fortifications surrounding the town, the exact lines of which have never been established (a contemporary map suggests alignments, but its reliability is questionable). During the excavations in Area A1 and Area E (in 2011 and 2013 respectively), large post-medieval ditches were uncovered that could form part of the siegeworks surrounding the town.

Post-medieval pits and ditches were exposed during the excavations at Area C1, C2, Napier Road and Circular Road North. This spread of 17th-19th century features is likely to continue into the Arena site. Uncovering elements of the 1648 siegeworks within the site is considered less likely (as none were identified in Area C2) but not impossible.

4. Aim

The aim of the evaluation was to record and establish the character, extent, date, significance and condition of any remains and deposits likely to be disturbed by the proposed works, in particular with reference to any potential archaeological deposits relatable to the information provided in Section 3 above.

5. Trial-trenching methodology and results (Fig 3-13)

This section provides an archaeological summary of the excavation of eleven trial trenches, including features, finds encountered and dating information. The trial-trenches were 1.8m wide, varied in length, and located across the readily accessible areas of the development site (Fig 3).

All potential burials encountered were only excavated to an extent whereby it could be ascertained they were likely to be burials. As a result, some assumed burials are labelled as only 'partially excavated' below.

The trial-trenches were excavated under archaeological supervision using a tracked excavator with a toothless ditching bucket. Four layers and forty-eight features were encountered across the site:

Context	Trench	Description	Finds	Date
L1	all trenches, apart from T6	dark grey/brown soft modern topsoil sealing L2 in every trench (apart from T6 where it had been removed prior to the laying of L4). varies in thickness from 350-600mm, depending on presence of L4.	frogged bricks, mod glass (none recovered)	modern
L2	all trenches	medium grey/brown loamy subsoil sealing the natural L3 and itself sealed by L1 (except in T6)	pot sherd	Roman

		where sealed directly by L4). varies in thickness from 100-400mm, depending on landscaping and amount of modern disturbance.		
L3	all trenches	mottled orange/brown/yellow sand. mixed natural subsoil underlying whole site. encountered at 700-900mm below ground level.	-	natural
L4	T1,T2,T5-T8	deposits of tarmac, crush and gravel making up the car park surface in several trenches. varies between 150-350mm thick.	-	modern
F1	T10	shallow 600mm wide ditch with medium grey/brown mottled fill aligned north-west/south-east. contained Roman burial F13. fully excavated.	pot sherds	Roman
F2	T10	ditch with medium grey/brown fill aligned north/south, 1.2m wide. copper alloy neck ring and two human molars recovered from southern end, likely remnants of an inhumation within the ditch. fully excavated.	pot sherds, brick, human teeth, cu alloy neck ring	Roman
F3	T10	north-east/south-west aligned 700mm wide cut disappearing into the northern baulk of T10. light yellow/brown sandy silt fill. possible ditch terminus, but light coloured fill and lack of finds could suggest natural feature.	-	?
F4	T10	400mm wide ditch aligned north/south with medium grey brown sandy silty fill. fe slag recovered from lower fill.	pot sherds, fe slag	Roman
F5	T11	small patch of silt with medium yellow/grey sandy fill. irregular base and sides suggest a natural feature.	-	post-glacial
F6	T11	shallow natural feature with irregular base and sides, with medium yellow/brown fill.	-	post-glacial
F7	T11	small posthole with soft dark grey/brown fill. likely modern in date	-	modern
F8	T11	large pit/possible service run only slightly inside eastern edge of T11.	metal tin, peg tile	modern
F9	T11	shallow natural gully aligned north-east/south west. irregular sides and base and leached fill.	-	post-glacial
F10	T9	a group of large rough green sandstone pieces sitting on the natural of L3, no visible cut. possibly packing for a post?	large pieces of green sandstone	Roman
F11	T10	small posthole with dark grey/brown fill with flecks of orange sand. likely associated with F12	frogged brick fragments	modern
F12	T10	similar to F11, small clearly modern posthole with dark grey/brown fill.	modern pot sherds (china)	modern
F13	T10	assumed inhumation, aligned north-west/south-east. cut into ditch F1. very similar fill to ditch, shape only distinguishable because of the coffin nails. small fragments of human bone recovered from fill.	?human bone fragments, fe nails, pot sherds	Roman
F14	T9	shallow 1m wide ditch aligned north/south terminating in T9. medium grey/brown sandy silt fill.	pot sherds, tile, green sandstone	Roman
F15	T9	small circular pit/posthole with diameter of 400mm and a depth of 150mm. medium sized bits of flint and green sandstone used in packing.	medium pieces of green sandstone	Roman
F16	T9	shallow 900mm wide ditch aligned north-east/south west in northern end of T9. mottled fill of medium grey/brown.	-	?
F17	T7	assumed inhumation, partially excavated at west	tile	Roman

		end. steep sides. medium yellow/brown sandy silt fill.		
F18	T7	assumed inhumation, not excavated. Same alignment and shape in plan as F17. medium yellow/brown sandy silt fill.	-	Roman
F19	T7	assumed inhumation, but no finds and orientated north-east/south-west, so not necessarily. only partially within T19. medium grey/brown sandy silt fill.	-	?
F20	T7	assumed inhumation, partially excavated at south end. aligned north/south. medium mottled grey/brown sandy silt.	pot sherds, tile fragments	Roman
F21	T7	small posthole, possible grave marker? Mottled brown/orange sandy silt fill. possibly Roman given proximity to graves, but not a certainty.	-	?
F22	T7	1.2m wide v-shaped ditch appearing to run north/south, although may be turning to west – difficult to say in confines of the trench. medium grey/brown sandy silt fill.	-	?
F23	T8	900mm wide linear aligned north/south, with medium grey/brown sandy silt fill.	peg tile, animal bone	post-medieval
F24	T8	assumed inhumation, although no finds. aligned north-west/south-east. only partially excavated, and only partially within T8. fill was a medium grey/brown sandy silt.	-	?
F25	T8	large (1.7m wide) ditch aligned broadly east/west. not fully excavated due to time restraints. medium grey/brown sandy silt fill.	peg tile, Roman tile (residual)	post-medieval
F26	T8	patch of natural silt. irregular base and sides, with leached light yellow/brown fill.	-	post-glacial
F27	T6	small oval pit with medium grey/brown sandy silt fill. 500m diameter.	-	?
F28	T6	assumed inhumation, although no finds. aligned north/south with straight sides and a flat base. medium grey/brown sandy silt fill, with occasional flecks of charcoal.	-	?
F29	T6	ditch aligned north/south, associated (and likely contemporary) with F30. 450mm wide. medium brown.grey sandy silt fill.	-	?
F30	T6	ditch aligned north/south alongside F29, 800mm wide. medium brown/grey sandy silt fill. possibly on same alignment as F4 in T10 (Fig 4), so could be the same ditch?	animal bone	?
F31	T5	assumed inhumation, only partially excavated. aligned east-west. medium grey/brown sandy silt fill.	pot sherds, animal bone,	Roman
F32	T5	large modern service cutting across southern end of T5, containing multiple services. likely is the same cut visible in edge of T6 (Fig 4).	-	modern
F33	T5	silt patch with leached fill and irregular base. light yellow/brown sandy silt fill.	-	post-glacial
F34	T5	400cm wide possible ditch aligned east/west. slightly curving northwards as it goes east. possibly a ring gully surrounding a burial, similar to some found in Area C2 (see above). medium mottled grey/brown sandy silt fill.	-	?
F35	T2	pit with diameter of 1.1m cutting Roman ditch F37. medium grey/brown sandy silt fill.	peg tile, Roman tile (residual)	post-medieval
F36	T2	oval shaped pit partially within T2. medium	peg tile, pot	post-

		grey/brown sandy silt fill. assemblage of Roman finds, but peg tile also recovered from feature, so likely to be post-medieval in date (unless peg tile residual).	sherds, animal bone, septaria pieces	medieval
F37	T2	ditch aligned north/south. cut by modern service to south of trench, and post-medieval pit to north (F35). full width never observed. could possibly have a grave cut into it, as seven nails were recovered from fill, as well as a large assemblage of Roman pottery.	pot sherds, animal bone, fe nails, Roman tile	Roman
F38	T2	circular pit with 700mm diameter, cutting through F37. dark grey/brown sandy silt with flecks of coal in fill. all finds recovered Roman, but coal in fill suggests a later date.	pot sherds, Roman Tile, worked flint	post-medieval
F39	T1	800mm wide ditch aligned slightly off north/south. medium brown grey sandy silt fill.	-	?
F40	T1	edge of shallow ditch observed in west of T1. cut by modern service. Medium grey/brown sandy silt fill.	Roman tile	Roman
F41	T2	850mm wide pit cutting through natural feature F42 and ditch F43. medium/dark grey/brown sandy silt fill.	pot sherds, fe nails, Roman tile	Roman
F42	T2	natural feature – possible tree throw? a bit deep for a silt patch. leached light yellow/brown sandy silt fill. cut to east by F41 and north by F43.	-	post-glacial
F43	T2	linear aligned north/south before possibly turning east at the northern end of T2. appears to be cut by pit F41 and cuts natural feature F42. medium grey/brown sandy silt fill. possibly the corner of an enclosure? difficult to interpret within the confines of the trench.	-	?
F44	T2	small posthole with diameter of 350mm. purpose unknown, but likely associated with F43 – might be located in the corner of an enclosure if F43 is turning east. dark grey/brown sandy silt fill.	-	?
F45	T1	small round pit with 800m diameter. medium yellow/brown sandy silt fill.	-	?
F46	T1	possible pit with diameter of 800mm. not fully within T1, comes out of the southern baulk. medium yellow/brown sandy silt fill.	-	?
F47	T1	450mm wide ditch aligned north/south and terminating within T1. light yellow/brown sandy silt fill. could possibly be a natural gully.	-	?
F48	T4	assumed inhumation, with flat base and straight sides. alignment not clear due to large amount of the feature being outside the trench, but likely to be east/west. medium grey/brown sandy silt fill.	fe nail, pot sherds	Roman

Trench 1 (Plate I)

T1 was 22m long and positioned in the northerly area of the development zone, just outside of the 10m 'buffer zone' surrounding the Roman circus Scheduled Monument (Fig 1). It was located on the very edge of the current car park, so half of the trench was sealed by L4 (tarmac and crush), and the other half sealed by L1 (turf and topsoil). The north side had 530mm of topsoil (L1) and 390mm of subsoil (L2) before encountering natural sand and gravels (L3). The south side had 400mm of tarmac and crush (L4) overlaying L1, which was only 140mm thick.

T1 was not excavated to the full length specified in the WSI (25m) due to the uncovering of multiple live services towards the north-east end of the trench, causing the machining to be cut short.

Five features were identified in T1: two pits (F45 and F46), and three ditches (F39, F40 and F47). Four features were undated, ie the shallow ditches F39 (800mm wide, 150mm deep) and F47 (600mm wide, 150mm deep) and the small pits F45 (880mm wide, 240mm deep) and F46 (810mm wide, 190mm deep). The only feature which could be dated is the ditch F40 (900mm wide, 140mm deep) which produced a fragment of Roman *tegula*.



Plate I T1 long shot. View facing south-west.
Modern services present in foreground.

Trench 2

T2 was 15m long and positioned to the north-west of the development, on part of the carpark. T2's stratigraphy consisted of 200mm of tarmac and crush (L1), sealing 150mm of topsoil (L2) and 360mm of subsoil (L3) before natural sand and gravels were encountered (L4). The south end of the trench contained a live service, so was not bottomed so as to avoid damaging it.

Eight features were identified in T2, four pits (F35, F36, F38 and F41), two ditches (F37 and F43), one natural feature (F42) and a posthole (F44). Two features were undated ie the ditch F43 and the posthole F44. The ditch F37 (1.2m wide, 500mm deep) and the pit F41 (1.7m wide, 410mm deep) both contained assemblages of Roman finds and are likely to be of that date. In particular 32 sherds of 2nd- to 3rd-century pottery were recovered along with Roman CBM from F37 whilst 3 sherds of similarly dated pottery derived from pit F41. Pit F38 (800mm wide, 100mm deep) also contained a Roman find assemblage but, due to the flecks of coal or coke observed in the fill of the feature, is likely to be post-medieval. Likewise, features F35 (1.1m wide, 400mm deep) and F36 (1.2m wide, 140mm deep) both contained Roman finds, but also pieces of peg tile, so were assigned a post-medieval date.

Several ferrous nails were recovered from the ditch F37, so there is a possibility that like the ditches in T10 (see below) there was a burial within its fill.

The group of features to the north end of T2 (F41-F44) proved difficult to interpret within the confines of the trench (Plate II). Specifically, it is not entirely clear if F43 turns to the east or if another feature is present between F41 and F44 that creates to illusion of F43 turning. This question would have to be resolved if this area becomes the subject of further excavation.



Plate II F43 and F44 in T2. View facing north.

Trench 3

T3 was located to the north-east of the development on part of the carpark that was not under tarmac. The trench was intended to be 18m long but, upon machining, it became clear that a large service containing potentially live services ran straight down the centre of our trench. Consequently this shortened length of T3 and it was immediately recorded and backfilled.

Trench 4 (Plate III)

T4 was a small 4m long partially hand dug trench on an overgrown patch of lawn to the north-east of the development site. The trench was placed between two live services to the east and west, so the 'window' into undisturbed archaeology was small.

T4's stratigraphy consisted of 430mm of topsoil (L1) sealing 230mm of subsoil (L2), before encountering natural sand and gravel (L3). One partially excavated feature was identified ie an assumed inhumation (F48, 1m wide, 290mm deep). The associated finds comprised 3 Roman pot sherds including a 2nd- to 3rd- century sherd, in addition to CBM and a probable coffin nail.



Plate III T4. View facing north.

Trench 5

T5 was 10m long and located on the east side of the development. It was dug through the gravel car park at the back of the Arena site. T5 was intended to be 15m long, but a live electric cable was identified using a cable avoidance tool at the south end of the proposed trench, so the decision was made to cut the trench short. Despite this decision, a large service run was still encountered in the southern end of the trench (F32).

T5's stratigraphy consisted of 310mm of tarmac and crush covered with gravel (L4), sealing 110mm of buried topsoil (L1) and 180mm of subsoil (L2), before encountering natural sand and gravels (L3).

Four features were identified in T5: one assumed inhumation (F31, 1.2m wide), the trench for a modern service run (F32), one natural feature (F33), and the end of a possible ring gully (F34, 500mm wide, 160mm deep). The inhumation was only partially excavated. As soon its shape was ascertained in plan and a sampling of finds were recovered the remainder of it was left undug to await a later stage of excavation, as specified in the WSI (RPS 2015). Finds from the grave included horse teeth, pieces of Roman CBM and 3 Roman pot sherds of mid 1st-, 2nd- or 3rd-century date.

Trench 6

T6 was 12m long and located in the centre of the development area. It was dug through the gravel car park at the back of the Arena site. T6 was intended to be 20m long, but plans and cable avoidance tools showed a live service to the eastern end of the trench, so it was cut short to avoid impacting it. Even though the trench was cut short, several services were encountered at the eastern end and across the north of the trench.

T6's stratigraphy consisted of 290mm of crush, tarmac and gravel (L4), sealing 400mm of subsoil (L2) before encountering natural sand and gravels (L3). Topsoil (L1) was not encountered in this trench, the laying of the tarmac and gravel surface having removed it entirely.

Four features were identified in T6: one small pit (F27, 500mm wide, 220mm deep), one assumed inhumation (F28, 600mm wide, 180mm deep), and two ditches aligned north/south (F29, 770mm wide, 170mm deep and F30, 1.1m wide, 340mm deep). The assumed inhumation had straight sides and a flat base, but no finds were recovered. The two ditches appear to be contemporary, and the westernmost one, F30, lines up with F4 in T10 (Fig 4). This suggests a Roman date for these ditches, although no datable finds were recovered.

Trench 7

T7 was 20m long and located to the west side of the development area. It was dug through the hardstanding behind the Arena. Its stratigraphy consisted of 140mm of tarmac and crush (L4) sealing 450mm of topsoil and 110mm of subsoil before natural sand and gravel was exposed (L3).

Six features were identified in T7: one ditch aligned north/south (F22, 1.2m wide, 610mm deep), one small posthole, possibly for a grave marker (F21, 450mm wide, 200mm deep) and four assumed inhumations (F17-F20). The ditch (F22) appears to run north/south, but its break of slope suggests it could be starting to turn to the west. The confines of the trench made it difficult to be entirely certain.

Of the assumed graves in T7, F17, F18 and F20 are the most convincing, being vertical sided on clear north/south (F20, 1.4m wide) or east/west alignments (F17, 600m wide and F18). F19 (800mm wide and 220mm deep) is less convincing. Its alignment is north-east/south-west and no finds were recovered during its excavation. F17 contained Roman CBM and F20 produced sherds from a mid 1st-, 2nd-, or 3rd-century flagon.

Trench 8

T8 was 25m long and located to the west side of the development area. It was dug through the hardstanding behind the Arena. Its stratigraphy consisted of 140mm of tarmac and crush (L4), sealing 450mm of topsoil (L1) and 120mm of subsoil (L2) before natural sand and gravel was exposed (L3).

Four features were identified in T8: two post-medieval ditches (F23, 1m wide, 380mm deep and F25, 1.8m wide), one assumed inhumation (F24, 900mm wide) and one natural feature (F26). The larger of the two post-medieval ditches (F25) was not bottomed due to time restraints, but appeared to be of substantial size. The assumed inhumation (F24) is aligned north-west/south-east with straight vertical sides. It was not bottomed and no finds were recovered from its fill. Roman inhumations have been identified on various alignments from cemeteries (such as Area J1) around the circus and therefore its alignment does not preclude a Roman date.

Trench 9

T9 was 25m long and located to the south of the development site, within Abbey Field. Its stratigraphy consisted of 400mm of topsoil (L1) covering 160mm of subsoil (L2) before encountering natural sand and gravel (L3).

Four features were encountered in T9: a Roman ditch (F14, 1m wide, 140mm deep), an undated ditch (F16, 900mm wide, 220mm deep), a posthole (F15, 400mm wide, 160mm deep), and a spread of greensand (F10). The posthole (F15) was packed with pieces of greensand and flint. The spread of greensand (L10) was lying in L2 and may have been associated with a former bank along the west side of F14. However, if this the case the bank is certain to have been disturbed by ploughing in the subsequent centuries and this spread of greensand is unlikely to be in situ. The Roman ditch (F14) contained 3 sherds of Roman pottery including an early-mid Roman sherd. The ditch may be paired with F4 in T10 as two parallel ditches flanking a north-south aligned trackway (Fig 4).



Plate IV T9 long shot. View facing south-east.

Trench 10

T10 was 40m long and located to the south of the development site, within Abbey Field.

T10's stratigraphy consisted of 430mm of topsoil (L1), sealing 360mm of subsoil (L2), before encountering natural sand and gravel (L3).

Six features were identified in T10: two modern postholes (F11 and F12), the terminus of an undated ditch (F3, 900mm wide, 190mm deep) and three Roman ditches (F1, 600mm wide, 270mm deep, F2, 1.1m wide, 250mm deep and F4, 1.45m wide, 450mm deep), one of which (F1) contained the burial F13 (Fig 8), and another (F2 – Fig 7) which contained human remains and a copper alloy neck ring (Plate V). The burial F13 (600mm wide, 300mm deep) was identified due to the collection of 18 coffin nails present within the fill, which otherwise was identical to F1. F13 contained 17 sherds of pottery of probable mid to late 2nd- or 3rd-century date. The assumed burial within F2 had no nails associated with it, and its exact cut was unknown (consequently it did not receive a feature number). The fill also contained Roman CBM and a sandstone fragment.

F4 is aligned north/south, and appears to line up well with F30 in T6 – suggesting they could be the same ditch (Fig 4). As noted above it may represent a trackway with F14 in T9. The fill contained 7 sherds of pottery of probable mid 1st-, 2nd- or 3rd-century date. The fill also contained Roman CBM, a ferrous nail and a piece of iron slag.

Trench 11

T11 was 25m long and located to the south of the development site, within Abbey Field. The trench originally was to be located 5m further east, but upon excavation a large service run for a sewer was found down the centre of the proposed trench, so it was backfilled and restarted further to the west. Its stratigraphy consisted of 300mm of topsoil (L1) sealing 360mm of subsoil (L2) before natural sand and gravels were encountered (L4).

Five features were identified in T11: three natural features (F5, F6 and F9), and two modern features (F7 and F8). The natural features all had leached fills and irregular sides and bases. There is a possibility that F9 is the terminus of a ditch, but the lack of finds and unconvincing fill make this unlikely. F7 is a modern posthole with dark silty fill, and F8 is a large patch of modern disturbance, possibly related to the large service run to the east (see above).



Plate V F2 completely excavated. Copper alloy neck ring (SF1) shown in situ to right of frame. View facing north-east.

6. Finds

Stephen Benfield

Introduction

Small quantities of bulk finds - consisting of pottery, ceramic building material (CBM), stone (building material), fired clay, iron nails, animal bone and slag – were recovered from features (which include graves) located in the evaluation trenches (T). The closely-dated finds are primarily of Roman date with a smaller quantity of post-medieval and modern finds, with one possible prehistoric worked/utilised flint. All of the bulk finds are listed and described by context in Appendix 1. In addition a single metal object was individually recorded as a small find (SF1) which is described and discussed separately.

The pottery fabrics and forms refer to the Colchester Roman and post-Roman pottery type series (*CAR 7* & *CAR 10*) with the addition of the fabric Black-surface wares (BSW). The fabrics recorded are listed in Table 1.

Fabric code	Description
<i>Roman:</i>	
AJ	Amphorae (Dressel 20)
BACG	Central Gaulish plain samian
BSW	Black-surface wares
CB	Colchester red colour-coated, roughcast ware
CZ	Colchester and other red colour-coated wares
DJ	Coarse oxidised and related wares
GB	BB2: black-burnished ware, category 2
GX	Other coarse wares, principally locally-produced grey wares
HZ	Large storage jars and other vessels in heavily-tempered grey wares
KX	Black-burnished ware (BB2) types in pale grey ware
<i>Post-Roman:</i>	
40	Post-medieval red earthenware (general)
48D	Staffordshire-type white earthenwares

Table 1 Pottery fabrics

Metal small finds

A decorated, annular, flat ring in copper-alloy (SF1) was recovered from ditch F2(8). Prior to cleaning and conservation, the surface of the piece is dirty and partly obscured. The ring broadens slightly toward the two ends which are simple and squared-off and overlap slightly. The upper surface is decorated with incised lines comprising a pattern of crosses bordered by linear (transverse) lines. This decoration can be seen to extend a short distance either side of the join but is not present around the whole circumference. The ring is thought to be part of an inhumation burial found in the ditch fill and was found adjacent to two human molar teeth (F2(4)) which are of a young adult consistent with an age of between 17-25 years. The teeth have been stained green, presumably by close association with the ring. If a burial, this suggests the piece was lying in the area of the neck, or possibly had been worn around the neck. The small aperture of the ring (105 mm) would suggest that if it is a neck ring, it could only be worn by a very young person. The ring or neck-ring is a significant find but not easy to parallel among published finds. However, it can be noted that an object identified as a bronze neck-collar or torc from a 1st century Roman burial from Harper Road, Southwark (London) is of strikingly similar appearance (see *Roman bronze neck-collar or torc: 1st century* <http://www.museumoflondonprints.com>). However, the object requires cleaning and research before any significant or secure comment can be made concerning its function and date; although a Roman date appears almost certain.

(Note - This object is currently with Colchester museums for cleaning and conservation, a full small find report will be added to this report when available).

SF1 F2(3) Grave/burial in ditch F2. Large annular ring in copper-alloy, flat (sheet) metal, slightly widening toward the overlapping join, surface decorated with incised lines making cross motif separated or bordered by linear (transverse) lines, the decoration extends a short distance either side of the join but is not present over the whole circumference (weight 21.2 g, dia. 105 mm internal, 116 mm external).

Human skeletal remains

Julie Curl

Bone from two grave contexts (F2 & F13) was submitted for analysis and comment.

F2(4) Two isolated teeth are a lower right 2nd molar and a lower right 3rd molar (unerupted); these weight 2 g. There is very little wear on the erupted 2nd molar, suggesting the age group of 17-25 years (following Brothwell 1981). The low wear on this tooth would indicate an individual at the lower end of that range. Both teeth are stained with copper alloy, suggesting that had lain next to a copper alloy object post burial.

F13(17). Eleven fragments of bone, amounting to 4 g was recovered from this feature. The bone is in poor condition and heavily fragmented, showing some wear on the surfaces. The bone is mammal bone and likely to be human, but there are no diagnostic features surviving which would confirm this.

Discussion

Prehistoric

Only one find may date to the prehistoric (pre-Roman) period. This is a flint, recovered from pit F35(38) in T2. This appears to be a natural, rolled flake of bullhead flint, but which has some use wear or retouch and can be described as a utilised piece or tool of convenience. While not closely dated this type of utilisation is considered to be more typical of the later prehistoric period (Bronze Age-Iron Age) than earlier.

Roman

The earliest dated Roman finds are of 1st-2nd century date and consist of pottery sherds from a probable ring-necked flagon and other sherds in oxidised fabrics (Fabric DJ) most of which which are probably from flagons and unlikely to date much past the early 3rd century. The bulk of the closely-dated Roman pottery is of 2nd-3rd century date and includes a sherd from a Central Gaulish samian mortarium of form Dr 45 (dated late 2nd century), local (Colchester) colour-coated beakers (Fabrics CB & CZ) and Black-burnished wares (Fabric GB). Although some pottery could date to the Late Roman period, notable a bowl of form Cam 299 F13(15) in T10 (dated to the period of the mid-late 3rd-4th century), there are no vessels or fabrics present which are typical of the Late Roman period of the late 3rd-4th century.

Some of the Roman pottery was recovered from the fill of features thought to represent graves, but which were not fully excavated during the evaluation (F13 (T10), F20 (T7), F31 (T5) & F48 (T4)). A significant number of iron nails associated with one of these features (F13) would support this interpretation; it is noted that another group of iron nails (seven in total) was recovered from the fill of ditch F37(34) in T2. The nails from F13 were individually plotted (F13(2) nails a-q). Another burial appears to be represented by finds from ditch F2 which consist human skeletal remains (HSR) consisting of two molar teeth from a young adult (F2(4)) and a large, flat, copper-alloy annular ring which is decorated on the upper surface (SF1) found in close association with the teeth. This ring is possibly a neck ring.

Some of the pottery recovered may also be suggestive of placed pots associated with burials or pots disturbed from burials. A Cam 299 bowl (mentioned above) from F13 is represented by large joining sherds forming a large part of the profile. A significant part of the base of a probable black-burnished ware dish was also recovered from F13(15). Another part pot consisting of much of the lower half of a Black-burnished ware style jar in greyware (Fabric KX) was recovered from the fill of ditch F37(34) in T2. Excluding a broken rim section from a samian mortarium (see above), the general range of pots could also be seen to be similar to that commonly placed with burials, including sherds from flagons, beakers in colour-coated ware and small-medium size jars and bowls. While this is subjective, these types of vessels appear to be well represented among what is a relatively small collection of pottery, beyond that which might be expected in a more domestic assemblage, and there is only a very limited presence of sherds from medium to large storage vessels.

Other Roman finds include pieces from broken bricks and tiles. These include *tegula* roof tiles, but no pieces from curved *imbrex* roof tiles were noted, suggesting that the Roman brick and tile represents a collection of flat pieces which were brought from elsewhere for reuse.

A piece of iron slag was also recovered from one feature, ditch F4(9) in T10, that also produced Roman pottery broadly dated to the mid 1st-2nd/3rd century. The slag may be part of a smithing hearth base. It can be noted that Roman smithing debris (dated from the mid 2nd-3rd century) was recovered from a site just to the north at Napier Road carpark (CAT Report 652).

A quantity of stone pieces was also recovered, notably three pieces of limestone/greensand from F10 in T9. The larger and better pieces of stone are almost all of limestone/greensand (F10, F14 & F37), with one piece of sandstone (F2). There are also pieces of septaria (F36 & F37) which are more broken-up and generally smaller pieces. The pieces identified as limestone-greensand are likely to be Kentish ragstone. They appear typical of the material known to have been used in the construction of the Roman circus located just to the north (although no secure province of the stone source or sources of the structure has been ascertained) and most likely derive from construction or demolition material associated with that structure, although this material may also have been used in the construction of other structures such as Roman mausolea.

Two human molar teeth were recovered from a burial made in ditch F2 (4). These are the only clearly identified human skeletal remains (HSR) recovered from the site, although a small quantity of undiagnostic bone from the fill of another feature identified as a grave cut (F13) is considered likely to be human. The teeth indicate the burial is that of a young adult aged 17-25 years and probably in the lower end of that age range.

Very little animal bone was recovered, although part of a fragmented horse jaw including four teeth together with other pieces of unidentified animal (large mammal) bone were recovered from the fill of F31(30) in T5 which is considered to be a probable grave cut. A sherd of greyware Roman pottery was recovered from the same feature.

Overall the condition and small quantity of animal bone recovered (and the lack of human skeletal bone other than teeth from a probable grave F2) suggests that in general bone is probably poorly preserved on the site.

Post-Roman

Pieces of relatively thin, hard tile which are identified as peg-tile were recovered from the fill of three pits (F8 (T11), F23 (T8), F35 (T2) & F36 (T2)) and one ditch (F25 (T8)). Roman tile, especially box-flue pieces can be quite thin, but there is no indication of Roman flue tile on the site and all these pieces are almost certainly post-Roman. The peg-tile pieces are not closely dated other than as broadly medieval to post-medieval. Pieces from a corroded, round, iron tin were also recovered from pit F8(6) together with a piece of coal indicating a probable relatively recent (modern) date for this feature. A piece of animal bone was also recovered from pit F23. Of undoubted modern date are pieces from a modern red, frogged brick from pit F11(12) in T10, which can be dated to the late 19th to 20th centuries.

Of note is an unstratified (US) find which is the base of a modern cup or small bowl (in three joining sherds) which belongs to the NAFFI (formerly located nearby at Roman Circus House) and is marked as produced for the NAFFI underneath.

Environmental report

Val Fryer

Val Fryer will provide the results of the analysis of thirteen environmental samples. These will be added to the report and included in the archive when they are available.

7. Discussion (Fig 6)

Although the evaluation trenching was cut short in places by modern services it provides a valuable insight into the surviving archaeology on the Arena site.

Based off nearby excavations, a number of inhumations were anticipated, and a number were indeed identified, within the development area (Fig 6). Although very few of these were fully excavated as per agreed WSI protocol, and some are more convincing than others (based on their alignment etc), enough have been securely identified to conclude that the Roman burial zone(s) respecting the south of the circus continue into the Arena site.

The two possible inhumation burials within F1 and F2 (in T10) are unlike the other possible inhumations uncovered on this site in that they seem to be buried within boundary ditches. Burials within and along boundary ditches are not an uncommon occurrence in Roman cemeteries and are similar to burials found in the Area J excavations and the Napier Road carpark site (CAT Report 412 and CAT Report 652 respectively).

A total of eleven potential inhumations were identified during Phase 1a (Fig 6), but they were not concentrated in one part of the evaluation area. The highest concentration of burials was in T7, with four inhumations identified. T2, T4, T5 and T6 all contained one each, with T10 having two inhumations within field boundaries (mentioned above). However, no burials were encountered outside of the ditched boundaries within the southern area of the site (i.e. the Abbey Field area). This spread of inhumations suggests burial activity across the whole site, albeit not in any great concentration (with the possible exception of T7).

The lack of cremations uncovered during this evaluation was not anticipated. The high number of cremations uncovered from the Abbey Field excavation of 2000 (72 in total), and the neighbouring site of Area C2 in 2004 (36 in total), were considered quite likely to extend into the Arena site. The lack of cremations (urned or otherwise) may indicate that the Roman burial ground(s) beneath the Arena are of a later date, when inhumations became a more popular practice (Crummy, P 1997, 108). Of course, the lack of cremations discovered could be due to the placement of the trenches and complete chance – such is the nature of evaluation.

No evidence was uncovered relating to the Roman tile kiln described in Hull's account (1958, 249). The discovery of burials on the site does suggest a chronological difference in space between the establishment of the kiln and the use of the site as a burial ground. As the kiln was discovered beneath the existing building, evidence for it may yet be uncovered in Phase 1b of this project.

The identified Roman field boundaries all run north/south, respecting the alignment of the circus, as well as the town further north. This north/south alignment (and related east/west alignment) of Roman field boundaries has been observed on several sites south of the circus and the Roman town (CAT Report 412, 13). In the confines of evaluation trenches any sort of positive determination of large landscape features can difficult at best, but two field boundaries in particular could be considered to form a trackway aligned north/south in T9 and T10 (Fig 4).

The Phase 1a evaluation has confirmed, in the broadest terms, that the archaeology surviving beneath the site of the Arena is of significance. The lack of cremations notwithstanding, the collection of burials and system of boundary ditches uncovered on this site represent a continuation of the Roman landscape observed in Area C2, the Abbey field excavation, and other nearby archaeological excavations over the last 15 years (Fig 2).

The required post-determination phase of evaluation (1b), consisting of trenching across the Roman circus and within the footprint of the demolished Arena building, will further our knowledge of the archaeological remains on this site and provide a basis for determining the size and scope of any required excavation.

8. Acknowledgements

CAT would like to thank RMPA for commissioning the project. The project was managed by C Lister, and the fieldwork was carried out by M Baister, S Conner, N Rayner, P Skippens, R Mathieson and E Sandford. Figures are by M Baister and E Holloway. The RPS consultant for the project was Rob Masefield. The project was monitored for Colchester Borough Council by Jess Tipper.

9. References

Bass, W.M	1995	<i>Human Osteology. A Laboratory and Field Manual.</i> Missouri Archaeological Society.
Brothwell, D.R.	1981	<i>Digging up Bones.</i> Cornell University Press.
CAT	1999	Policies and procedures (updated 2014)
CAT	1999	<i>CAR 10</i> , Robin Symonds and Sue Wade, <i>Roman pottery from excavations in Colchester, 1971-86</i> , Colchester Archaeological Report 10
CAT	2000	CAT Report 97, <i>An archaeological desk-based assessment of the Colchester Garrison PFI site</i> , by Kate Orr
CAT	2000	<i>CAR 7</i> , John Cotter, <i>Post-Roman pottery from excavations in Colchester, 1971-85</i> , Colchester Archaeological Report 7
CAT	2007	CAT Report 424, <i>An archaeological excavation on the Abbey Field car-park, Circular Road North, Colchester, Essex</i> January-February 2007, by Howard Brooks, Ben Holloway and Rob Masefield
CAT	2011	CAT Report 412, <i>Archaeological investigations on the 'Alienated Land', Colchester Garrison, Colchester, Essex</i> May 2004 October 2007
CAT	2014	CAT Report 652, <i>Stages 2 & 3 archaeological monitoring and excavation on the Napier Road car parks and footpath (GAL Area B1b and C2), Colchester Garrison, Essex</i> February 2011 - January 2013, by Adam Wightman, Donald Shimmin, Stephen Benfield, and Rob Masefield
CAT	2015	CAT Report 778, <i>Roman burials, buildings, and enclosures west of Mersea Road, Colchester: Stage 3 archaeological excavation at Colchester Garrison Alienated Land Area E (GAL E)</i> January 2013, by Howard Brooks, with contributions by Ben Holloway, Stephen Benfield, Nina Crummy, Julie Curl, Val Fryer, Rob Masefield (RPS), Adam Wightman, and Emma Holloway (illustrations)
CAT	forthcoming	CAT Report 628, <i>Archaeological evaluation and excavation at Colchester Garrison Area A1 (former Meeanee & Hyderabad Barracks), Mersea Road, Colchester, Essex, October-December 2010, January-March 2011</i>
ClfA	2008a	Standard and guidance for archaeological field evaluation.
ClfA	2008b	Standard and guidance for the collection, documentation, conservation and research of archaeological materials.
Crummy, P	1997	<i>City of Victory: the story of Colchester, Britain's first Roman town.</i>
EAA 8	2000	Research and Archaeology: a frame work for the Eastern Counties 2 Research agenda and strategy, East Anglian Archaeological Occasional Papers 8, ed. by Brown, N. and Glazenbrook, J.
EAA 14	2003	Standards for Field Archaeology in the East of England. East Anglian Archaeology, Occasional Paper 14, ed. by David Gurney
EAA 24	2011	Research and archaeology revisited: A revised framework for the East of England, East Anglian Archaeology Occasional Paper 24, ed. by Maria Medlycott
Hull, M.R.	1958	<i>Roman Colchester</i>
MoRPHE	2006	Management of Research Projects in the Historic Environment (English Heritage)
RPS	2015	<i>Written Scheme of Investigation (WSI) for stage 1a archaeological trial trenching evaluation at the Arena, Circular Road East, Colchester, April 2015</i> , by Rob Masefield

10. Abbreviations and glossary

CAT	Colchester Archaeological Trust
CBM	ceramic building material (brick, tile, tessera).
context	specific location of finds on an archaeological site
ECC	Essex County Council
EHHER	Essex Historic Environment Record, held by Essex County Council
ERO	Essex Records Office
feature	an identifiable thing like a pit, a wall, a floor; can contain 'contexts'
fill	the soil filling up a hole like a pit or ditch
HEA	Historic Environment Advisor
imbrex	form of interlocking Roman roof tile, paired with <i>tegula</i>
ClfA	Chartered Institute for Archaeologists
layer	an accumulation or deposition of archaeological material
post-medieval	the period from AD 1500 to AD 1800
Roman	the period from AD 43 to AD c410
medieval	the period from AD 1066 to AD 1500
modern	the period from AD 1800 to present day
natural	geological deposit undisturbed by human activity
NGR	National Grid Reference
OS	Ordnance Survey
tegula	form of interlocking Roman roof tile, paired with <i>imbrex</i>

11. Contents of the archive

Finds archive

2 Museum boxes containing all finds.

Paper archive

1 A4 wallet containing:
this report
original site record (context and finds sheets)
section drawings
digital photo log
attendance record
sundry papers
digital photos on disc

12. Archive deposition

The paper and digital archive are currently held by CAT at Roman Circus House, Roman Circus Walk, Colchester, Essex, C02 7GZ, but will be permanently deposited with Colchester Museum (under accession code 2015.43).

Distribution list:

RMPA
Jess Tipper (Colchester Borough Council Archaeological Officer)
Rob Masefield (RPS)
EHER



Colchester Archaeological Trust

Roman Circus House,
Roman Circus Walk,
Colchester,
Essex CO2 7GZ

Tel: 01206 501785

E-mail: archaeologists@catuk.org

*checked by: Philip Crummy
date: 08/06/2015*

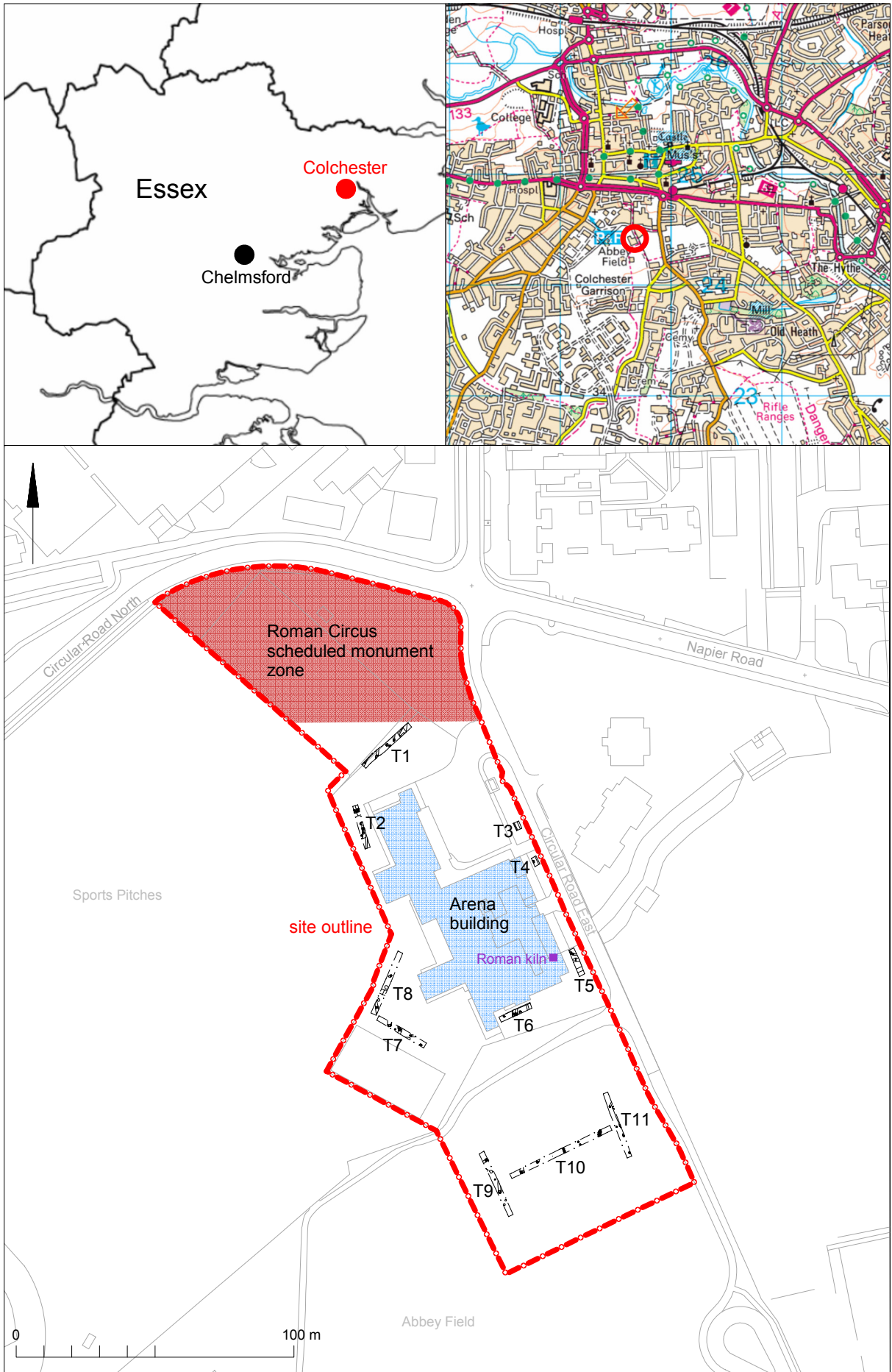

Fig 1 Site location.

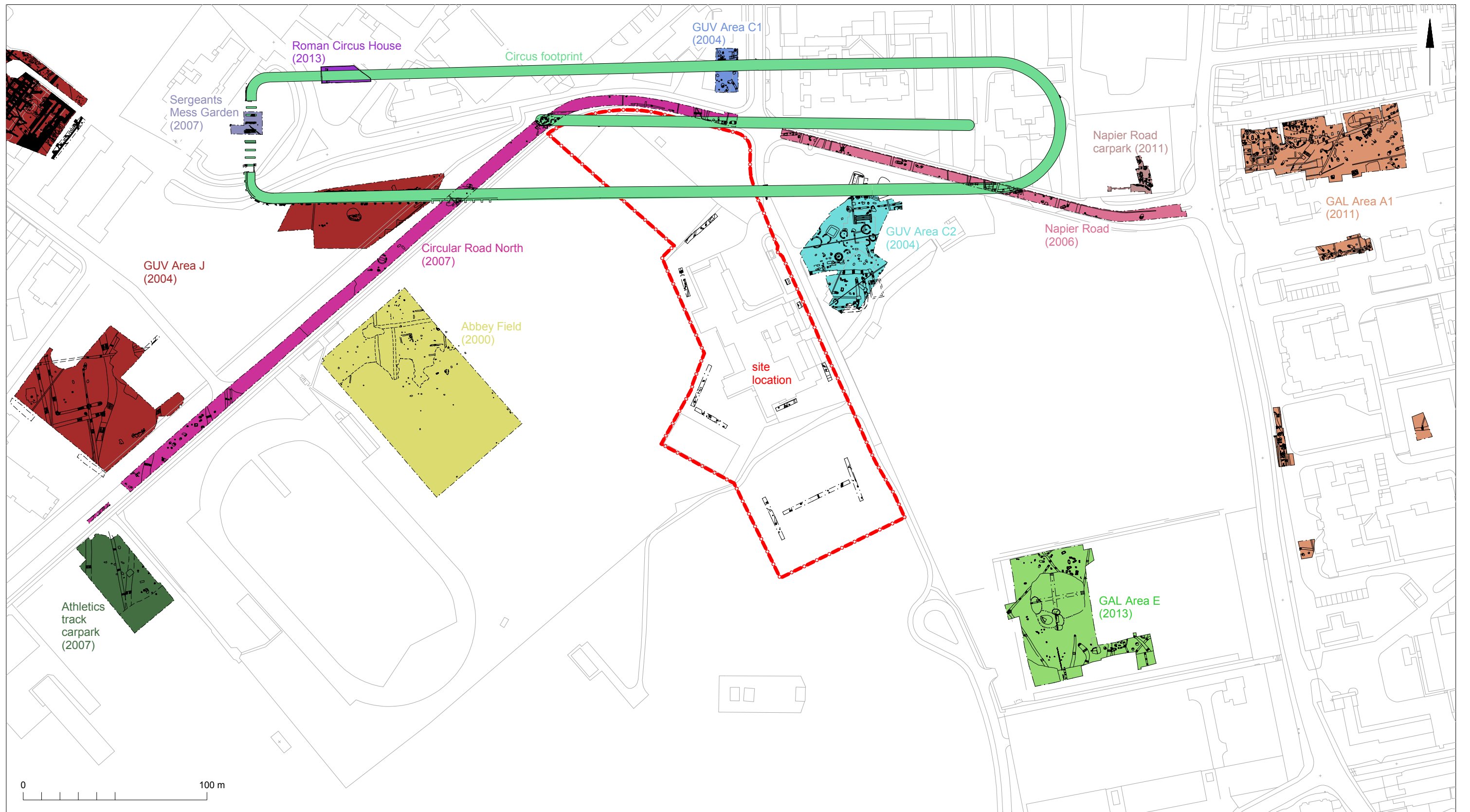

Fig 2 Arena site shown in context with nearby excavations.

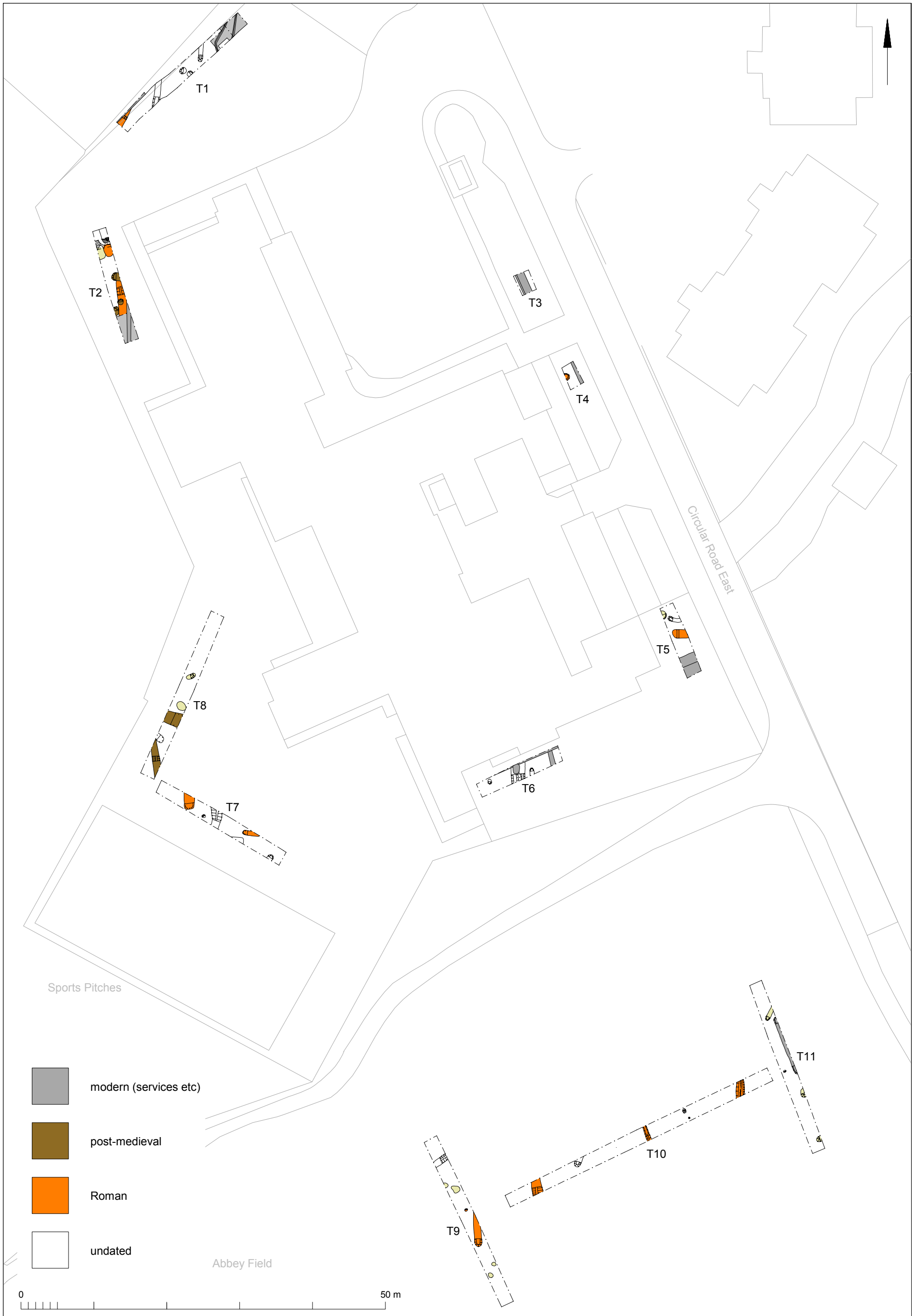

Fig 3 Evaluation results.

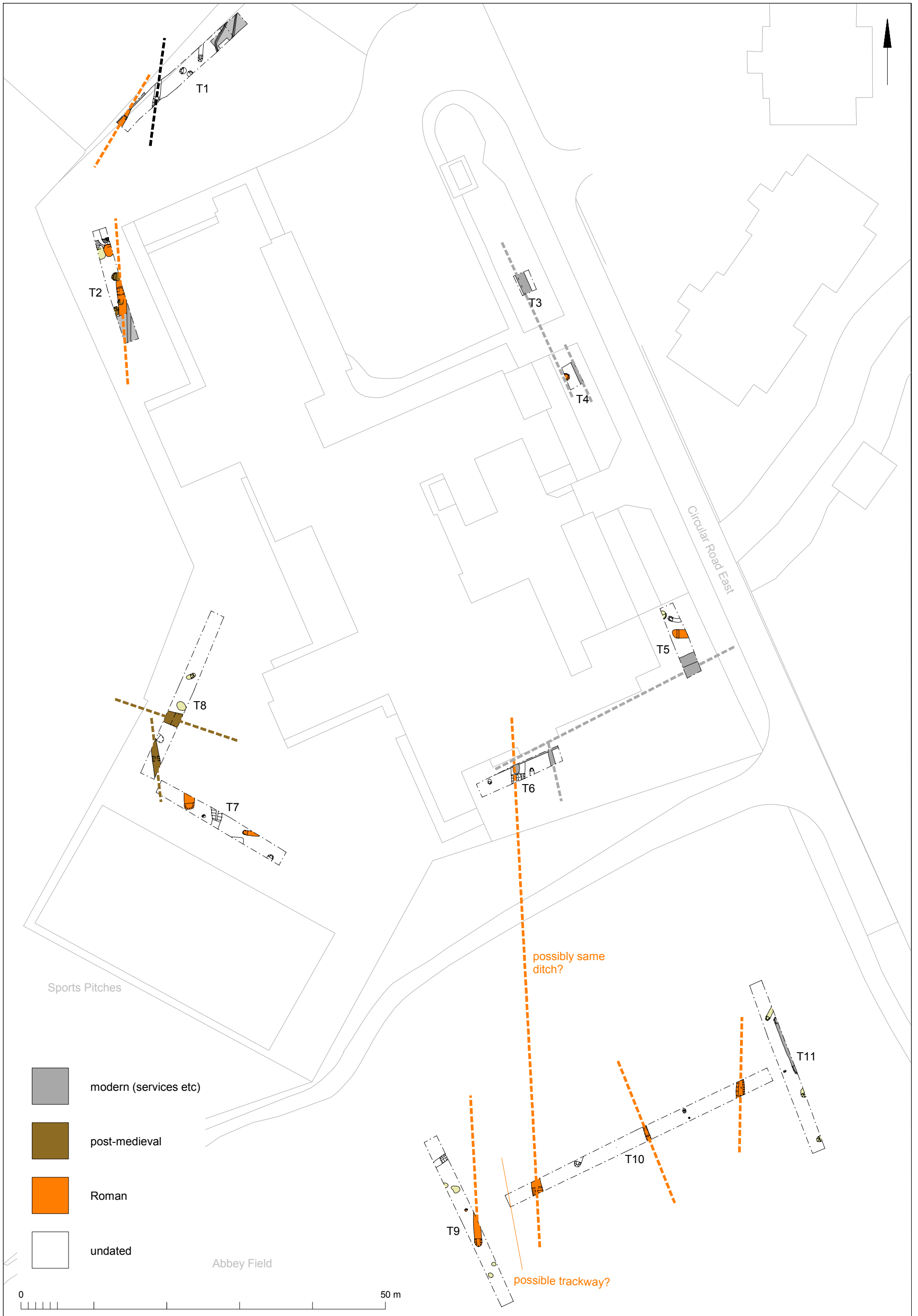
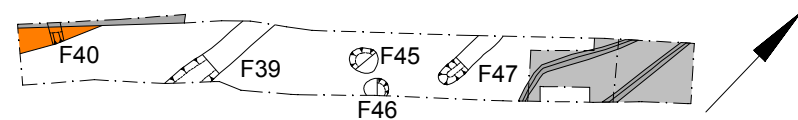
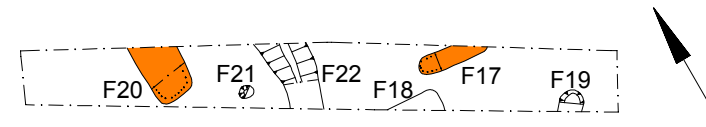

Fig 4 Evaluation results with extrapolated ditches (and modern services).



T1



T7

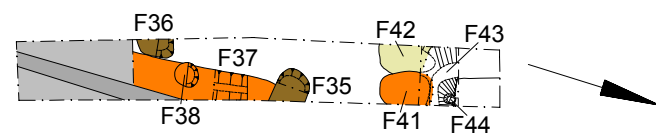

T2

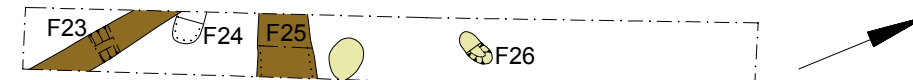

T8

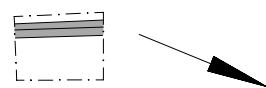

T3

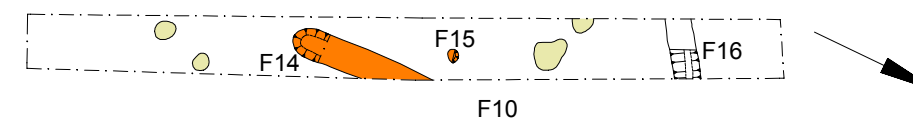

T9

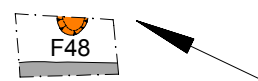

T4

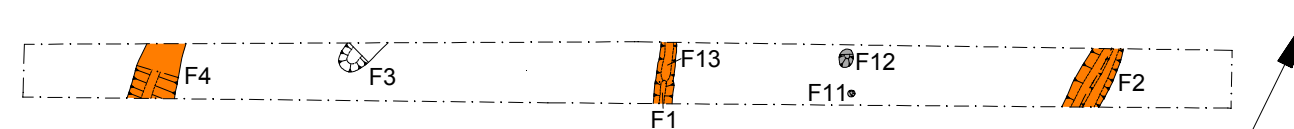

T10

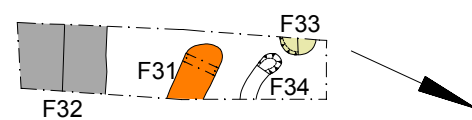

T5

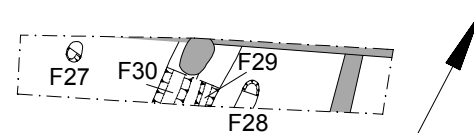

T6

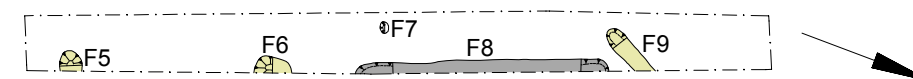

T11





-  modern (services etc)
-  post-medieval
-  Roman
-  undated



Fig 5 Detailed trench plans.

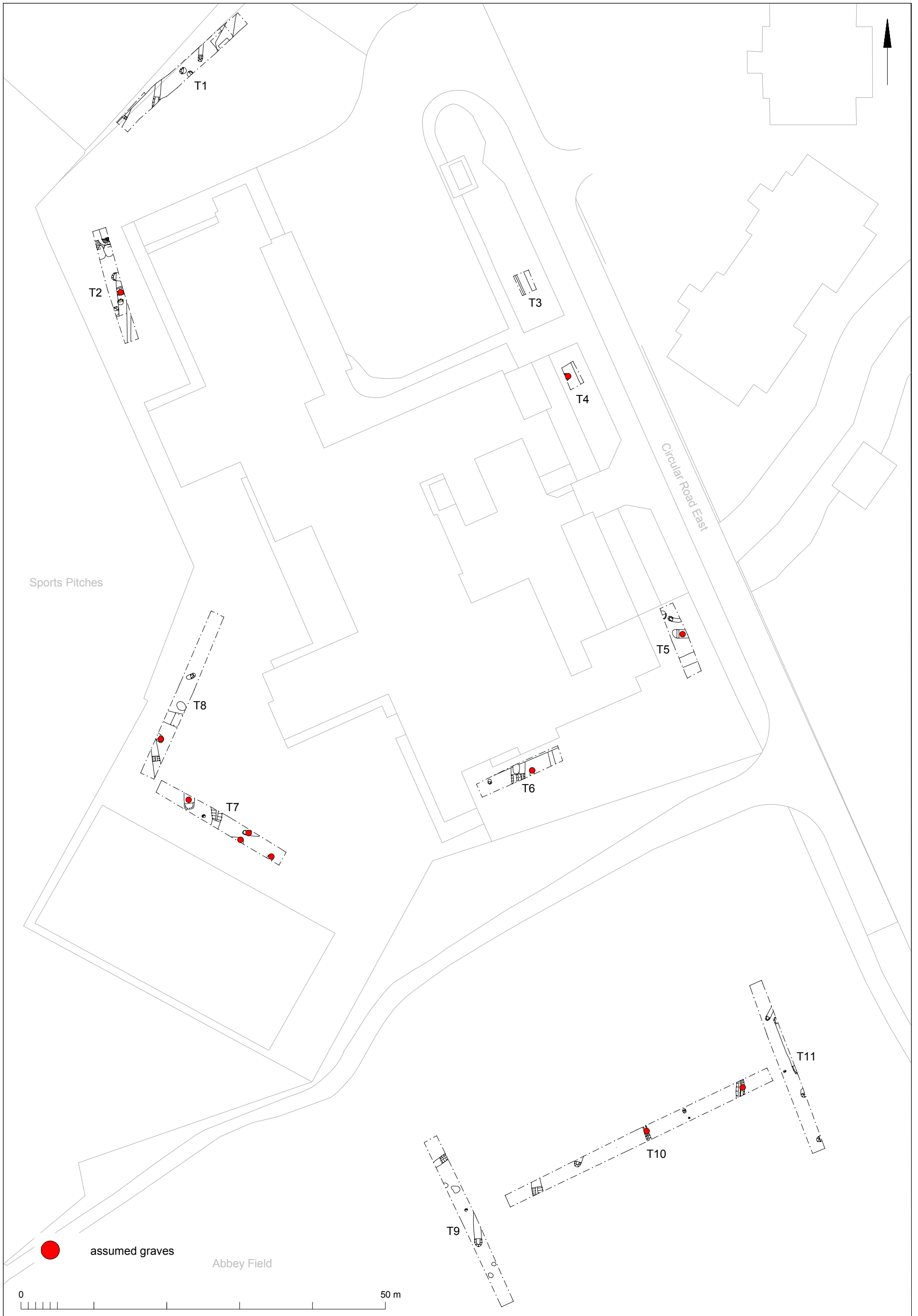

Fig 6 Evaluation results with assumed graves highlighted.

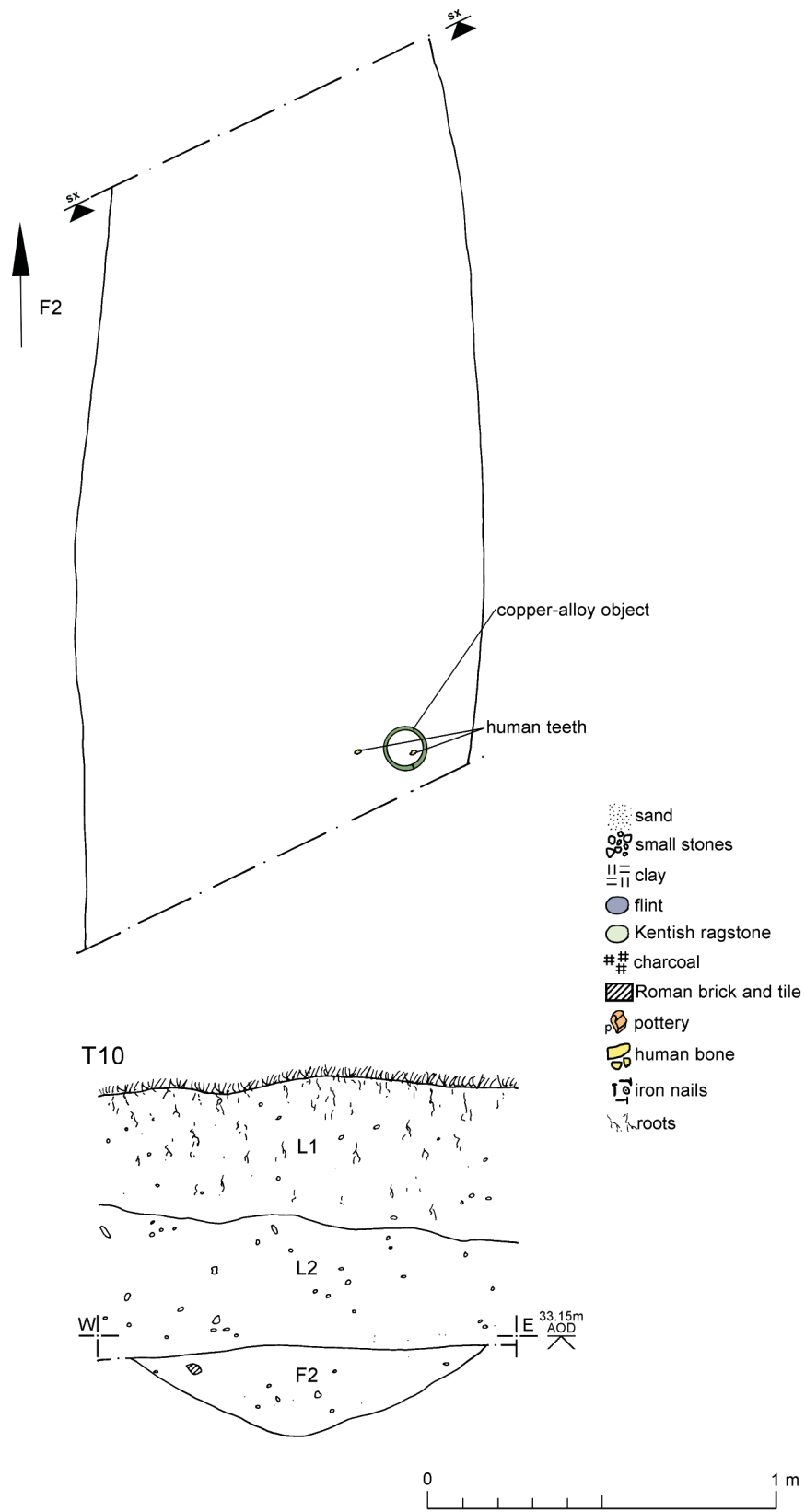

Fig 7 Burial plan and section (F2).

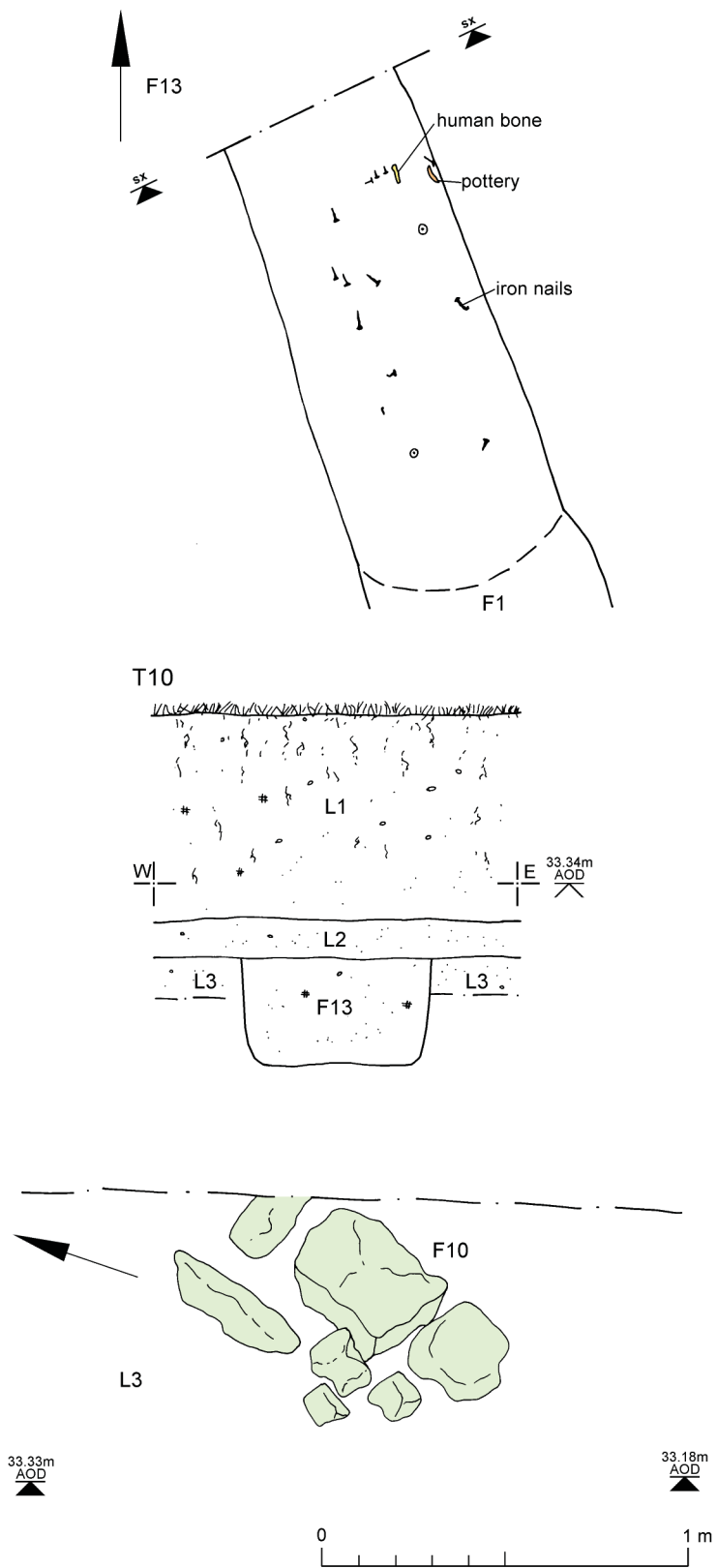

Fig 8 Burial plan and section (F13) and plan of stone spread (F10).

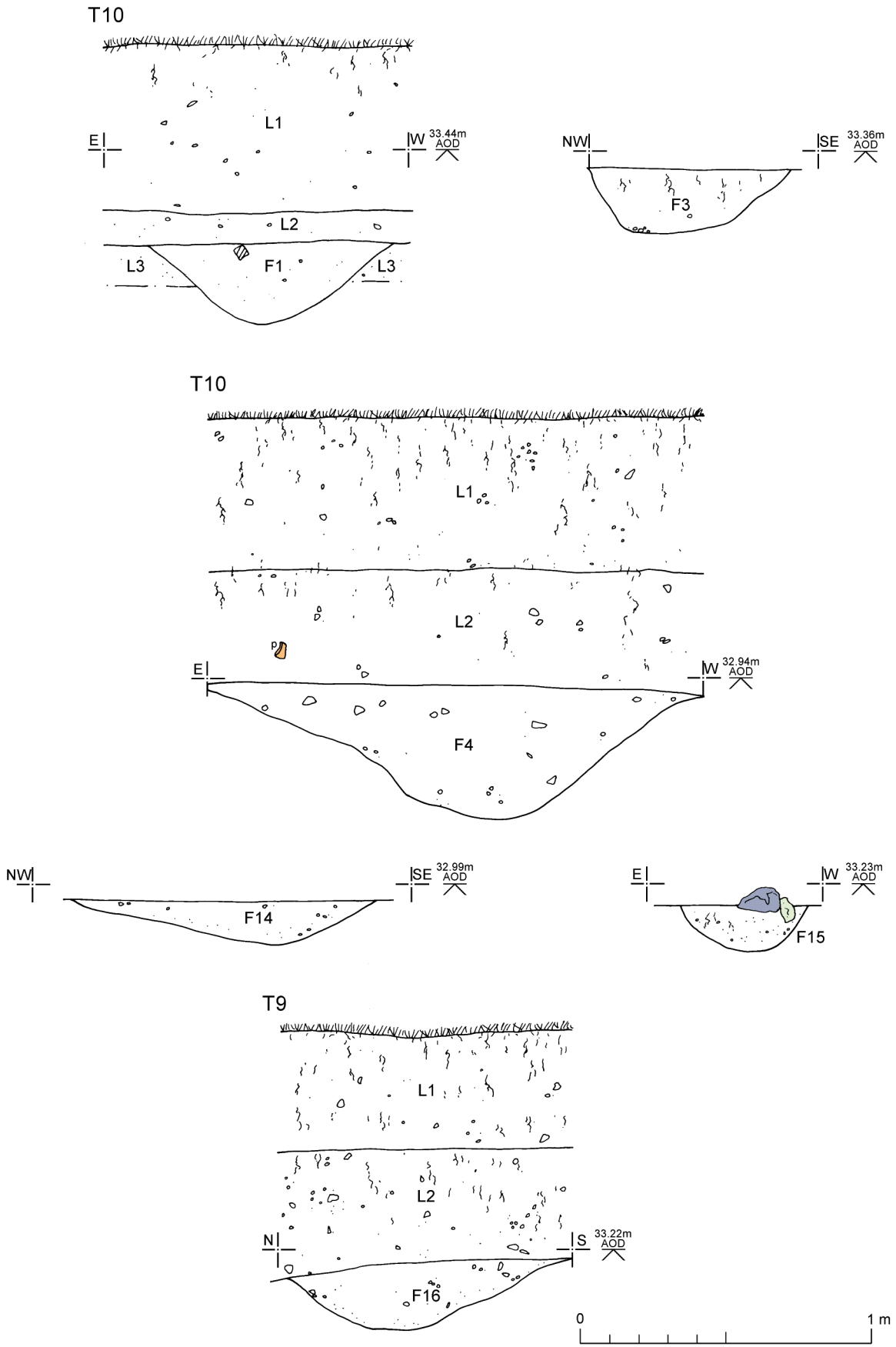

Fig 9 Feature sections.

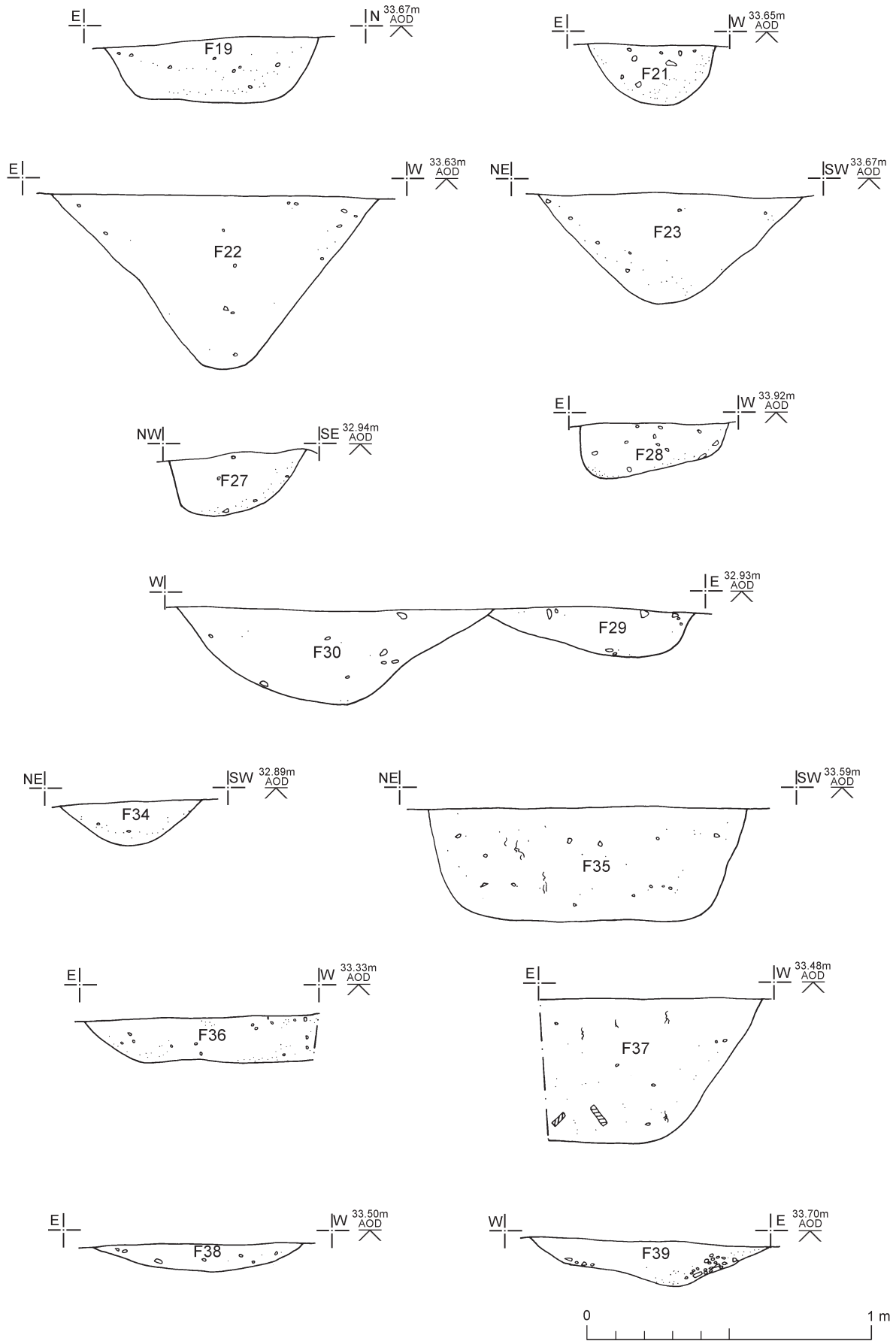

Fig 10 Feature sections.

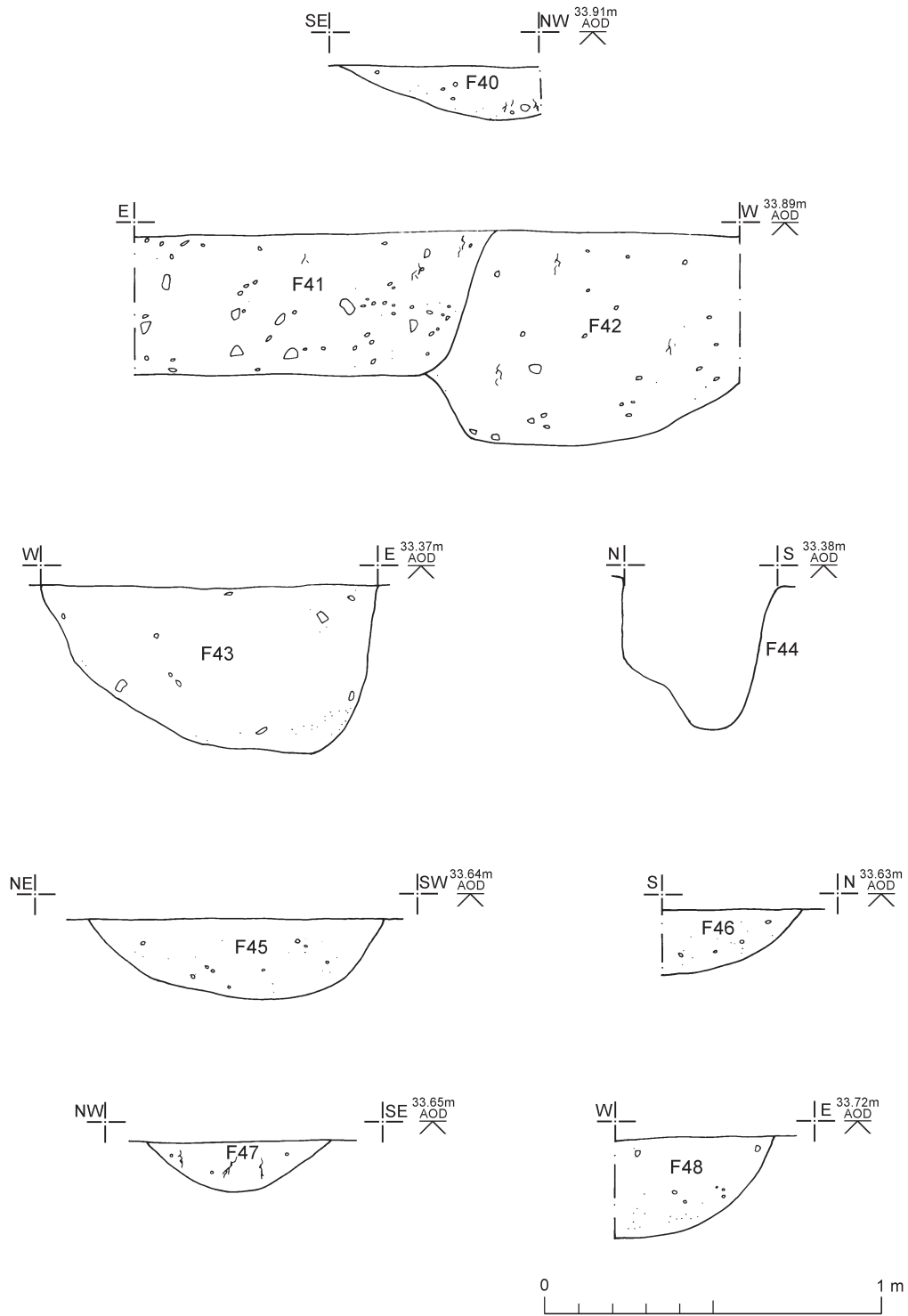

Fig 11 Feature sections.

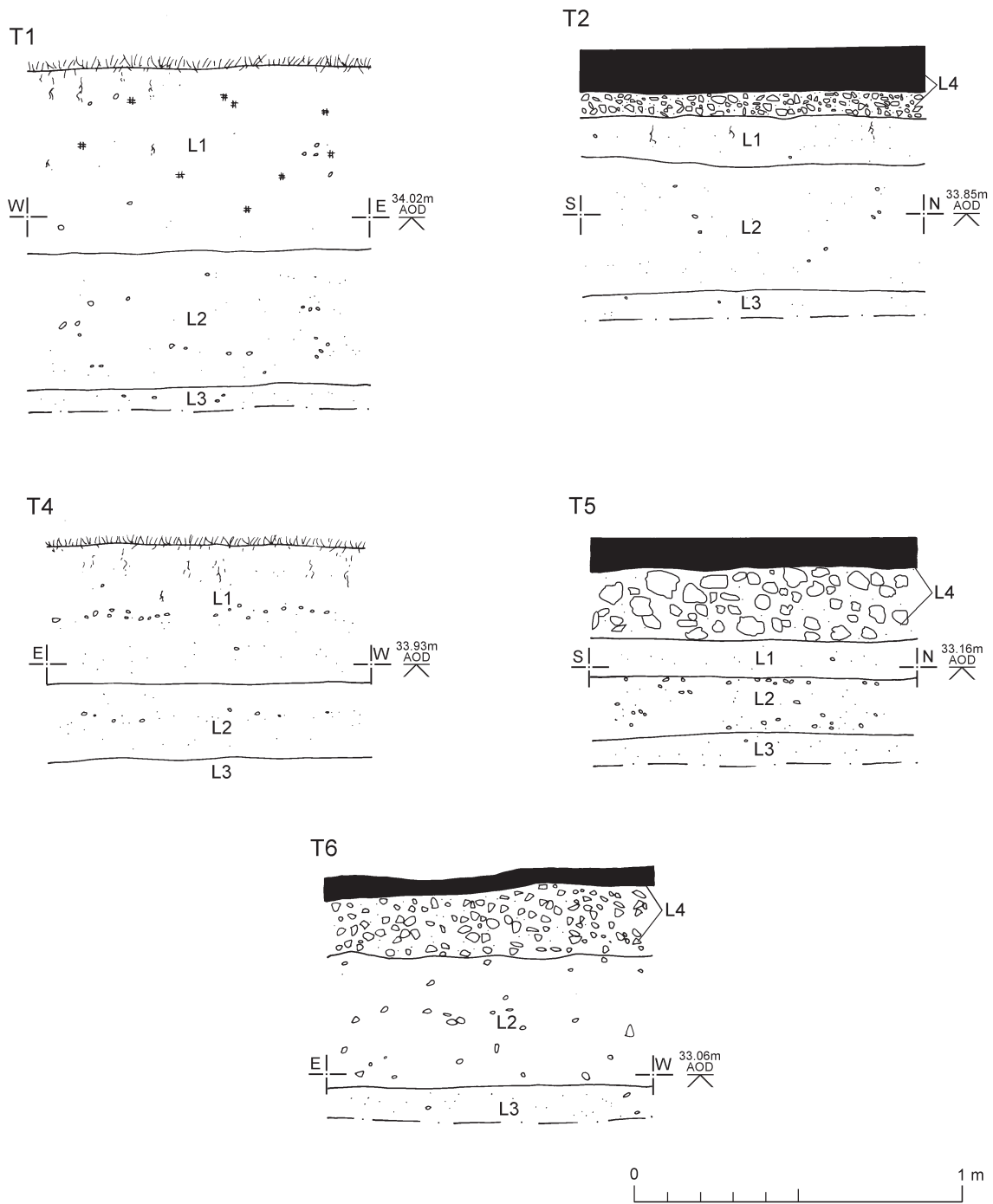
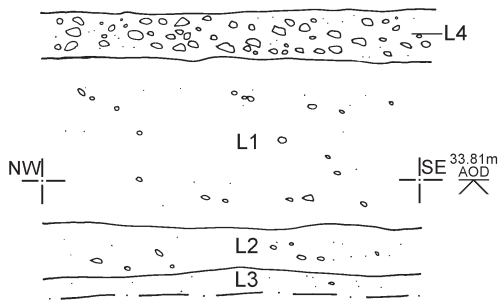
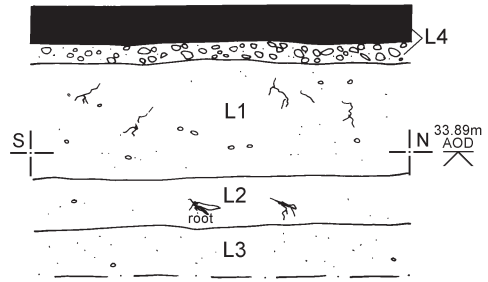

Fig 12 Representative trench sections.

T7



T8



T9

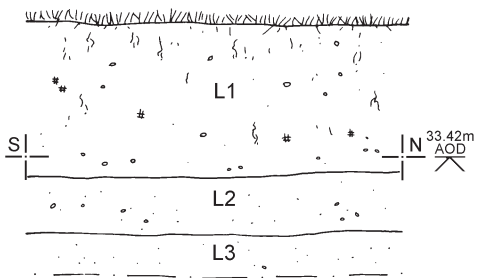

T11

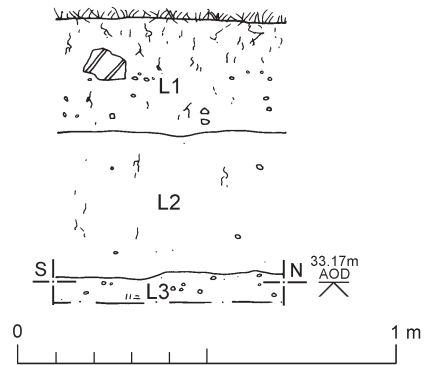

Fig 13 Representative trench sections.

Finds Appendix

T	ctxt no.	find no	Ctxt type	Find type	Finds description	Fabric code	form	Eve	no	Wt/g	Period/spot date
1	F040	36	linear	CBM	probably tegula. thickness 16 mm, red fine sand fabric		RBT		1	31	Rom
2	F035	32	pit	slate					2	13	p.med-mod
2	F035	32	pit	CBM	abraded		RBT		1	91	Rom
2	F035	32	pit	CBM	thin tile piece, peg-tile, coarse sandy fabric		PT		1	27	p.med-mod
2	F035	32	pit	nail/iron	corroded piece of small bar, most probably a nail shank				1	52	
2	F036	33	pit	CBM	red sandy fabric, 30 mm thick		RBT		1	130	Rom
2	F036	33	pit	CBM	thin tile piece, peg-tile, coarse sandy fabric		PT		2	24	p.med-mod
2	F036	33	pit	pot	jar base, abraded	GX	jar		1	30	Rom
2	F036	33	pit	pot	dish	40		0.03	1	7	L16-18C
2	F036	33	pit	stone	septaria pieces				4	286	
2	F036	33	pit	A bone	large mammal-cattle/cow, moderate-poorly preserved				3	141	
2	F037	34	ditch	pot	rim and body sherds from a samian mortarium	BACG	Dr 45	0.14	7	104	M-L2C
2	F037	34	ditch	pot		DJ			1	7	M1-2/3C
2	F037	34	ditch	pot		BSW			1	2	Rom
2	F037	34	ditch	pot	includes base sherd	GX			4	31	Rom
2	F037	34	ditch	pot	SV (part pot) base (joining sherds) and body sherds, grouped vertical burnished lines	KX			9	111	M/L2-M/L3C
2	F037	34	ditch	CBM	Roman flat tile pieces, red sandy fabric, faint (small) animal foot imprints on two pieces		RBT		14	1912	Rom
2	F037	34	ditch	CBM	flanged <i>tegula</i> pieces, red sandy fabric, base 20-23 mm thick		RT		2	579	Rom
2	F037	34	ditch	CBM	40 mm thick, red sandy fabric		RB		1	160	Rom
2	F037	34	ditch	nails	corroded iron nails, shaft pieces up to 57 mm long				7	92	Rom
2	F037	34	ditch	stone	septaria pieces				5	1403	Rom
2	F037	34	ditch	stone	limestone/greensand, one piece with white deposit on face - appears to be a natural deposit				2	330	Rom
2	F038	35	pit	pot	SV, joining base sherds	GX			2	31	Rom
2	F038	35	pit	CBM	red sandy fabric		RBT		2	136	Rom
2	F038	35	pit	flint	probable utilised				1	12	preh?

T	ctxt no.	find no	Ctxt type	Find type	Finds description	Fabric code	form	Eve	no	Wt/g	Period/spot date
					piece - flake-like piece of Bullhead flint, but with no indication of flake detachment but with edge damage or retouch/ use wear on edges, piece generally glossed from rolling						
2	F041	37	pit	pot	beaker	CZ			1	5	E/M2-3C
2	F041	37	pit	pot		GX			1	1	Rom
2	F041	37	pit	pot	base from a dish or bowl, abraded	BSW			1	20	Rom
2	F041	37	pit	nails	corroded pieces from iron nails				2	23	
4	F048	40	pit/ grave	CBM	35 mm thick, probably Rom brick, red sandy fabric		RB		1	190	Rom
4	F048	40	pit/ grave	CBM	small pieces, slightly abraded		RBT		4	68	Rom
4	F048	40	pit/ grave	nail	small corroded iron nail/ stud with flat round head				1	5	Rom
4	F048	40	pit/ grave	pot	BSW fabric, probably GB (BB2)	GB	dish		1	8	E/M2-3C
4	F048	40	pit/ grave	pot		GX			1	7	Rom
4	F048	40	pit/ grave	pot		HZ			1	8	Rom
4	L002	42		pot	slightly abraded	GX			2	10	Rom
5	F031	30	grave	pot		GX			1	4	Rom
5	F031	30	grave	A bone	Horse teeth (4) and part of jar bone, several other large bone pieces, moderate condition				10	172	
6	F030	27		A bone	large mammal, poorly preserved				2	7	
7	F017	23	grave	CBM	flanged <i>tegula</i> piece, red sandy fabric , base 20 mm		RT		1	178	Rom
7	F020	22	grave	pot	abraded, sherds from a flagon	DJ			3	4	M1-2/3C
7	F020	22	grave	CBM	slightly abraded, red silty fabric		RBT		1	37	Rom
8	F023	26	linear	A bone					1	2	
8	F023	26	linear	CBM	thin tile piece probably peg-tile, coarse sandy fabric		PT		1	57	med-p.med
8	F025	25	ditch	CBM	flanged <i>tegula</i> piece, red sandy fabric , base very thin at 15 mm		RT		1	83	Rom
8	F025	25	ditch	CBM	one abraded		RBT		2	72	Rom
8	F025	25	ditch	CBM	thin tile piece, peg-tile, coarse sandy fabric		PT		1	39	p.med-mod
9	F010	20	cut?	stone	limestone/ greensand, three large rough pieces, approximately 6000				2	6000	Rom

T	ctxt no.	find no	Ctxt type	Find type	Finds description	Fabric code	form	Eve	no	Wt/g	Period/spot date
					g in weight						
9	F014	19	ditch	stone	limestone/greensand				1	984	Rom
9	F014	19	ditch	CBM			RBT		1	58	Rom
9	F014	19	ditch	pot		DJ			1	3	M1-2/3C
9	F014	19	ditch	pot		GX			1	8	Rom
9	F014	19	ditch	pot		BSW			1	6	Rom
10	F001	1	ditch	pot	base	GX			1	68	Rom
10	F002	4	ditch	HSR	Human molar teeth, one tooth with root and second tooth crown only, limited wear on surfaces, both stained green by proximity to copper-alloy				2	2	(Rom)
10	F002	11	ditch	CBM	Roman brick, red silty fabric, appears heat affected (discoloured)		RB		1	245	Rom
10	F002	11	ditch	stone	sandstone piece (building stone)				1	583	Rom
10	F004	7	ditch	F clay	abraded small orange piece				1	6	
10	F004	7	ditch	pot	Dressel 20 amphora, abraded	AJ			1	61	M1-E/M3C
10	F004	7	ditch	pot	slightly abraded	DJ			2	16	M1-2/3C
10	F004	7	ditch	CBM	tile surface piece		RBT		1	2	Rom
10	F004	7	ditch	nails	corroded shank				1	6	
10	F004	8	ditch	pot	SV, abraded	BSW			3	14	Rom M1-2C?
10	F004	8	ditch	pot	SV, join, flagon neck sherds	DJ	Cam 155		2	52	M1-M2C
10	F004	9	ditch	slag	relatively heavy, vesicular iron slag, possibly from a smithing hearth base				1	254	Rom
10	F011	12	p-hole	CBM	red frogged brick		BR		5	974	L19-20C
10	F013	2	grave	nails	18 medium size iron nails individually plotted (nails a-r) presumed to be from a coffin				18		Rom
10	F013	15	grave	CBM	red sandy fabric		RBT		1	159	Rom
10	F013	15	grave	pot	SV joining sherds, BSW fabric, probably GB (BB2), possibly same pot as F48(40)	GB	dish		3	70	E/M2-3C
10	F013	15	grave	pot	rim & body sherds, more than one pot, rims from 2 jars	BSW		0.14	5	17	Rom
10	F013	15	grave	pot	more than one pot	GX			4	19	Rom
10	F013	15	grave	pot	folded beaker	CB			1	2	E/M2-M3C
10	F013	15	grave	pot	SV, joining sherds, part pot, bowl with girth groove	GX	Cam 299	0.21	4	150	M/L2-4C
10	F013	17	grave	bone	one piece and several fragments of fragile, degraded bone				1	4	

T	ctxt no.	find no	Ctxt type	Find type	Finds description	Fabric code	form	Eve	no	Wt/g	Period/spot date
11	F008	6	pit	iron	pieces from a round iron tin				4	17	mod (19-20C)
11	F008	6	pit	CBM	thin tile piece, peg-tile, coarse sandy fabric		PT		1	13	med-p.med
11	F008	6	pit	coal					1	25	p.med-mod
-	US	-		pot	SV, base of NAFFI cup or small bowl, legend on base: N.A.F.F.I FURNIVAL'S VITRIFIED ENGLAND	48D			3	29	20C

Appendix 1 Bulk finds by context (SV=same vessel)

**WRITTEN SCHEME OF INVESTIGATION
(WSI) FOR STAGE 1a ARCHAEOLOGICAL
TRIAL TRENCHING EVALUATION AT THE
ARENA, CIRCULAR ROAD EAST,
COLCHESTER**

April 2015

April 2015

Our Ref: RM/JLQ0015

RPS
14 Cornhill
London
EC3V 3ND

Tel: 020 7280 3200
Fax: 020 7283 9248
Email: rpslp@rpsgroup.com



CONTENTS

1	INTRODUCTION	2
2	ARCHAEOLOGICAL AND HISTORICAL BACKGROUND.....	6
3	STRATEGY AND AIMS	12
4	METHOD STATEMENT.....	14
5	PUBLIC ARCHAEOLOGY.....	20
6	HEALTH AND SAFETY.....	21
7	FINDS.....	22
8	REPORTING	24
9	ARCHIVE AND FINDS DEPOSITION	25
10	STAFFING AND TIMETABLE	26
11	MONITORING	27
12	REFERENCES	28

APPENDIX 1

Team Structure

FIGURE 1

Plan of all Garrison project areas (Showing Berechurch Dyke) (after CAT)

FIGURE 2

Proposed trench layout at Colchester Arena showing Roman Circus

1 INTRODUCTION

- 1.1 This written scheme of investigation (WSI) is for ~~Stage 1a~~ trial trenching at The Arena Leisure Centre, Circular Road East, Colchester, CO2 7SZ (TL 997 244) on behalf of RMPA Services Plc.
- 1.2 The pre-determination trenching is required in support of an Outline Planning Application for residential (c.100 units) and commercial development, including landscaping and car parking. The archaeological procedures follow the protocols used for the separate RMPA development of the New Garrison and the related ~~Alienated Land~~ residential re-development of former barracks by Taylor Wimpey (formerly Taylor Woodrow). This process includes trenching of land parcel before grant of planning permission. ~~Stage 1a~~ trenching is inevitably constrained by current site use and thus provides a contribution towards the minimum percentage by area (i.e. 3-4%) that has been required for the above projects.
- 1.3 In this case it is possible to achieve a 2.3% sample of the c.1.9ha Arena Site, entailing eleven 1.8m wide trenches with a combined area of 432m². At a meeting with the Colchester Borough Council Archaeological Officer (CBCAO) on 2nd April 2015 it was confirmed that for the purposes of the present application the Stage 1b trenching requirement is likely to exceed the minimum 3-4% level (i.e. will be greater than the residual 0.7-1.7%). Stage 1b trenching will be undertaken subsequent to Outline Planning permission and potentially following demolition of the existing buildings.
- 1.4 The northern area of the proposed development site (henceforth the ~~Arena Site~~) will allow for a ~~Roman circus interpretation zone~~ as a landscaped space. This is because the Arena Site is coincident within Colchester Circus which was designated a Scheduled Monument in 2007 (Historic England National Monument No: 35614) (RPS 2015, Appendix 1 for description). Details of the Roman circus and other aspects relating to the archaeological potential of the of the Arena Site are provided in detail within a companion desk-based archaeological assessment (RPS 2015) which should be read in conjunction with this Written Scheme of Investigation (WSI). Figure 2 shows a dashed line on the south side of the circus which represents the full extent of the Scheduled area (i.e. including a 10m buffer zone)
- 1.5 The Scheduled Monument implications have been discussed in a pre-application meeting with Historic England in attendance of 16th July 2014 and again at an on-site meeting with Deborah Priddy of Historic England and the CBCAO of 2nd April 2015. At the 2014 meeting it was agreed that the reporting process should include the aforementioned baseline report in addition to this WSI for Stage 1a trial trenching. Historic England require this WSI to form part of the notification for archaeological works within the SM but it is now understood that a full SMC process will not be required for Stage 1a as the two proposed trenches indicated on Figure 2 within the SM are to be conducted as part of the Stage 1b works following consent.
- 1.6 As a result of Historic England and CBCAO requirements that the Roman Circus and its Scheduled 10m buffer zone, to the south side, would be accommodated within grassed open space (with surface representation probably using grass banks to represent the cavea walls and central barrier (spina) as at Alienated Land Area J1 to the east and Area C1 to the north). As noted the two trial trenches indicated on Fig. 2 will be required within the current tennis courts area as part

of the Stage 1b works to assess the depth, form and quality of preservation of the associated remains. The data on survival and form will inform the above ground interpretation of the remains. The depth information would assist in provision of a future method statement for current surface removal and subsequent topsoil provision. These proposals would need to be agreed by Historic England (assuming grant of planning permission) as part of another Scheduled Monument Consent application. The northern of the two circus related trenches is designed to intercept the central barrier and track whilst the southern to intercept the double southern cavea wall lines (i.e. the seating stand).

- 1.7 The Stage 1a trenches are located to the south of the circus within areas of the Site that would be subject to development following planning permission. The primary archaeological potential here relates to Roman pottery manufacturing, due to the discovery of a Roman pottery kiln during foundation construction for the military NAAFI (the current Arena building) in 1946 (RPS 2015). It is however, unlikely that all related evidence was removed during its investigation. The UAD records held by Colchester Borough Council suggest its location was in the south-east area of the building in the area shown on Figure 2, although Hull (1958) seems to locate the kiln further the west (see RPS 2015. Appendix 2). Given the ambiguity investigation of both areas is likely to be required (post-demolition) at Stage 1b.
- 1.8 Roman burial grounds are known to have flanked the southern side of the Roman circus with significant cemetery concentrations known from Abbey Field/Circular Road North (c.100 burials) and Alienated Land development Area C2 which comprises the new build to the immediate east side of Circular Road East (c.64 burials) (RPS 2015). Therefore the desk-based assessment has identified potential for the Arena Site to contain further burials. The principal medieval site in the area is St John's Abbey which lies to the north-east. However the DBA indicated the Arena Site probably lay within farmland at this time (ibid).
- 1.9 The ditched elements of a probable star shaped English Civil War fortlet and its associated larger offensive ditch were located just east of the junction of Mersea Road with Napier Road during the archaeological investigations of Alienated land Area A1 (the north-east area of the former Hyderabad and Meeanee Barracks). The fort and larger (offensive ditch) were part of the New Model Army's Civil War offensive positions, but are further north than previously expected . almost against the wall of St John's Abbey which was defended by the Parliamentarians under Lucas. This confirms that original offensive positions which are shown on the Colchester Siege Map and included Fort Needham which had been presumed to lie near the south-west corner of Area A1, had been moved forward as successful campaign progressed. Given the east-west alignment of these positions it is possible the offensive line could also be encountered within the Arena Site (although notably no such remains were encountered during investigations at Area C2 to the immediate east).
- 1.10 This document is specifically designed to provide a sound basis for excavation and post excavation practice for the completion of the trial trench and any subsequent works. The WSI sets out proposals for the archaeological work including treatment of finds, production of a report, and deposition of the archive. The WSI mirrors standards and practices contained in Guidelines on Standards and Practices for Archaeological Fieldwork in the Borough of Colchester (Colchester Borough Council's 1996. revised 1999). The Colchester Borough Council Archaeological Officer (CBCAO) requires this document in order to formally approve scope of the

evaluation and the aims and methods for archaeological recording and reporting. The WSI is prepared by RPS in association with CAT and will be adhered to by CAT.

- 1.11 This WSI is in accordance with the National Planning Policy Framework (March 2012) which includes the following:

“...local planning authorities should require an applicant to describe the significance of any heritage assets affected, including any contribution made by their setting.

Where a site on which development is proposed includes or has the potential to include heritage assets with archaeological interest, local planning authorities should require developers to submit an appropriate desk-based assessment and, where necessary, a field evaluation.” (Section 12, Paragraph 128)

2 ARCHAEOLOGICAL AND HISTORICAL BACKGROUND

2.1 Drift geology of the area is predominantly sands and gravel. This is occasionally in a clay matrix, and is sometimes capped by about 300mm of cover loam (ibid). The Arena site is broadly flat. Present ground levels in this area are recorded at c.34.11m AOD at area C1 to the north and c.34.05m AOD at C2 to the east (ibid). The archaeology relating to the circus is usually found to cut the cover loam at a depth of c.300mm whilst other archaeological features are normally identified at the lower level of the underlying gravel. Archaeology in this area can therefore be anticipated at levels between c.33.50 and 33.80m AOD (based on Area C1 and C2 levels).

2.2 The archaeological and historical setting of the Arena Site and its surrounding area has been comprehensively explored in the desk-based assessment (RPS 2015) and will only be summarised here.

a) Neolithic and Bronze Age

2.3 Neolithic and Bronze Age features (mainly pits) have been identified during the Alienated Land project within Areas C1, C2 immediately north and east of the Arena, with a further example within Flagstaff Road (CAT 2011). There are currently no Neolithic or Bronze Age finds known from the Site. The Area C1 pits contained both Mildenhall Ware and Peterborough Ware may have been transitional between to the middle/late Neolithic traditions (CAT Report 412, 2011). A pit within Alienated Land Area C2 to the immediate east of the Arena contained Beaker pottery typical of the late 3rd millennium to early 2nd millennium BC (RPS 2015).

2.4 A late Bronze Age occupation pits was identified in 2004/5 and 2013 to the west of Abbey Field, in Alienated Land Areas J1 and H (CAT 2011). Late Bronze Age pits were also found in the northern zone of St John's Abbey (UAD event 3019) and within Alienated Land Trench WBT4 (CAT 2011) at Flagstaff Road, whilst a Bronze Age burial urn was found in the southern area of Abbey Field (UAD event no. 1237). A pit/posthole (CRNF50) containing probable Late Bronze Age/Early Iron Age sherds was also found during the Circular Road North works to the west side of Abbey Field (CAT 2011).

b) Iron Age and the Oppidum

2.5 The Arena falls within the eastern area of the pre-Roman (late Iron Age) oppidum of Camulodunum (RPS 2015). The only above-ground traces of this oppidum are the linear banks and ditches of the defensive dyke system that surrounded it but the closest of these is located in the south-east corner of the current residential development area of the former Hyderabad and Meeanee Barracks well to the east of Mersea Road (ibid). The oppidum has only two main confirmed centres of activity: at modern Gosbecks Farm (2km south-west of the Garrison), which was a Late Iron Age (LIA) and Roman rural farmstead (and possibly the home of the Catuvellani tribe's king, Cunobelin); and Sheepen (2km north-west of the Garrison), which was the industrial and trading centre. Apart from these two large centres it is likely that there were a number of smaller domestic and farming sites in the oppidum. One of these farms was identified by the field boundaries paddocks and other features recorded at Kirkee & McMunn Barracks in 1994 (Shimmin 1998: figs 8, 11) and another farmstead with origins in the latest Iron Age was

investigated in 2010 at the former Goojerat Barracks (CAT 2012). Late Iron Age cremation urns were also found within mitigation Area 6 for the New Garrison in 2003 to the east of Kirkee McMunn Barracks (CAT in association with RPS 2005) and in the southern and south-eastern areas of Abbey Field in 1904 and 1905 (west of the TA Centre) respectively (UAD event nos. 1246 & 1248).

- 2.6 Three minor ditches within Area C1, immediately to the north of the Arena, although undated, pre-date the Roman circus and may belong to the Late Iron Age or earliest Roman field systems. More securely, two parallel driveway ditches (CRNF41 & CRNF42) contained probable Middle-Late Iron Age sherds and several other Iron Age features were excavated west of the sports pitches on Abbey Field during the relaying of Circular Road North (CAT 2011).

c) Roman period overview including background to the Roman Circus and burial grounds

- 2.7 Since its identification in 2004 the plateau of flat ground c.400m to the south of the Roman town, including the northern extent of the Arena, has been known to contain nationally/internationally important Roman archaeology in the form of a stone built monumental Roman circus for chariot racing (RPS 2015 Figs 2 to 6). The circus is currently unique to Britain and was been investigated within Alienated Land Areas C1, C2 and J1 in 2004 and 2005, with further walls and a monument base uncovered during service works at Napier Road in 2006 (CAT 2011). The western end of the spina was found beneath Circular Road North in 2007, whilst the starting gates themselves were partially exposed by CAT excavations in 2007 (*ibid*). Trial trenches within the former Flagstaff House compound (Area B1b) have recorded cavea walls associated with the semi-circular eastern end. Metalling of an exterior track was found in one location at the north-east end of the circus, whilst erosion of the dirt track was encountered around the location of the eastern end of the spina (central barrier).
- 2.8 CAT has also investigated a section of the northern cavea within what are now their office premises at the Former Officers Quarters, Le Cateau Barracks. The east-west orientated circus is approximately 450m in length and 70m wide with a central spina barrier around which the charioteers completed 7 laps. Elements identified to date include the seating (stands) known as the cavea - with internal and external (buttressed) walls, two entrance ways through the southern cavea, a lowered racetrack dirt surface (the removed topsoil was presumably used to construct caveat banks on which seating was constructed), a segment of the semi-circular end of the circus, a fragment of the starting gates structures (demonstrating bays for eight chariots rather than twelve), a monument base on the line of the spina in the cross roads of Flagstaff Road/Circular Road East with Circular Road North/Napier Road (for an obelisk?), and further elements of the spina, including its western end and a fragment of a turning post pillar (metae) just to the west of the Arena Site within circular Road North.
- 2.9 The outer wall of the circus was apparently pulled down in the late Roman period, as represented by rubble spreads exterior to the outer wall noted in the excavations, whilst the inner (podium) wall fell forwards into the track in some areas (e.g. at Napier Road). This evidence suggests a seating bank between the walls was still upstanding when the walls fell. In some area (e.g. at Areas C1, C2 and in B1b) a metalled surface representing a track has been identified around the circus.

- 2.10 Colchester Urban Archaeological Database records include a single site reference within the Arena itself (UAD event no. 615). This comprises the discovery of a Roman tile kiln by the construction team in 1946 whilst excavating the foundation for the NAAFI (alter the Arena Leisure Centre). Hull records (1958, 248-9, no.193) also records the find at TL 997244 which is plotted at the south-east side of the main building (Fig. 2 shows the approximate location of the kiln but may not be accurate). There are no other records within the Arena, apart from the notable exception of the extrapolated southern cavea, track and central spina of the Roman circus at its northern end (based on the records from the investigations, as summarised above).
- 2.11 Numerous Roman burials have also been found to the south of the circus during the Taylor Wimpey Colchester Garrison development areas in the vicinity of the Arena, most notably (in terms of proximity) within Area C2, Napier Road Car Park & Napier Road (collectively over 100 burials). Over 400 burials were excavated further to the west within Taylor Wimpey Area J1 (near Butt Road) in 2004 (CAT 2011) with a further c.380 excavated within adjacent Area H adjacent to Butt Road in 2012 and early 2013 (CAT forthcoming). Two lead coffin burials are known to the east of the Arena Site at Circular Road East and Area C2. In total 68 Roman burials comprising cremations and inhumations were excavated at Area C2. These comprised mainly 3rd to 4th century burials including within a stone mausoleum (the lead coffin) and 11 ring-gully defined former barrows that contained cremations. The ring-gully forma has precedents in the Germanic Rhineland area of the Netherlands and on Hadrian's Wall, and combined with certain artefacts suggest both possible Germanic and military associations (CAT 2011; RPS 2015).
- 2.12 At Abbey Field works funded by RMPA have included an evaluation and excavation of the new car park on the east side of Circular Road North (CAT March 2006 & Oct 2007) and associated with cable trenches and the seating stand to the west of the Arena site (CAT Dec 2005 and Dec 2006). The scatter of cremation burials encountered by these works (associated with a track . see below) enlarge the previous extent of a known burial ground. At least 28 Roman cremation burials had been found in 1925 when part of Abbey Field was originally levelled for sports purposes (Hull 1958, 255). More recently examples have been excavated at the Abbey Field artificial sports pitch in 2000 when at least 72 cremation burials and pyre-related features were recorded (CAT 2000) (RPS 2015, Figs 4 & 6). These cemetery plots to the south side of the circus *might* extend into the Arena site. However, the Roman kiln is atypical of Roman cemetery sites and infers some separation of activities, or a chronological difference in the use of this space (e.g. the kiln pre-dated the cemetery).
- 2.13 In terms of Roman road infrastructure the remains of a major Roman road junction is located north-west of the former military garrison, under Colchester Boys High School, from which roads radiated out to London, the Roman site at Gosbecks (CAT 2000; Crummy 1997). Mersea Road to the east of the Arena is also likely to overlay the course of a Roman road to the town's south-east gate. In addition a wide Roman ditched and metalled track or road was found in Taylor Wimpey land parcel Area J1, the adjacent Circular Road North and Abbey Field Car Park. This route would appear to link with the aforementioned road junction if continued to the north-west, whilst it continued southwards into the rural hinterland of the town. In a similar fashion to the circus perimeter this route was a focus for Roman burials of early to late Roman date. As noted a gravel track also extended around the perimeter of the Roman circus, providing access to various stands for the spectators.

2.14 The Abbey Field area also forms part of the rural hinterland south of the Roman town and the circus/burial grounds. The Alienated Land project has located two early Roman farms in the vicinity of the Arena, one at the new Primary School site (Area E1 on Fig. 1) and a second which developed from a late Iron Age predecessor to the south-west side of Abbey Field (Area N on Fig. 1). The Area E1 farm is located within the school sports field to the west of Mersea Road. The archaeological investigation identified a Roman enclosure containing a small Roman building which may be part of a farmstead or even a villa-type building. A subsequent excavation (CAT forthcoming) for the school building area identified a large Roman quarry, further enclosure/field boundaries and several cremation burials, including a bustum (*in-situ* cremation) burial.

d) Saxon

2.15 5th to 7th century early Saxon burials were found in the late 19th century to the north of the former Hyderabad Barracks (Area A1) and east of Mersea Road/B1b. A Saxon cremation was also recovered from Hyderabad Barracks itself in 1926. This burial ground extended south into the north-west corner of the former Hyderabad Barracks where about 70 inhumation graves investigated in 2010 were probably mainly of 6th-7th century Anglo-Saxon date (CAT forthcoming). Three graves contained Anglo-Saxon weapons (spear heads with iron shield bosses) and were associated with at least four ring-ditches of probable barrows, similar in form to late 3rd century Roman examples at Area C2/Napier Road/ Circular Road North. These graves are important as they are potentially associated with the mechanism of the coming of the English.

2.16 Later Saxon evidence for the period was identified in 1972 when the remains of the small Anglo-Saxon church of St John were excavated before the construction of St Botolph's roundabout.

e) Medieval

2.17 The remains of St John's Abbey are the dominant standing archaeological feature in the vicinity of the Arena Site. The Benedictine Abbey of St John was founded by Eudo close to the site of the Anglo-Saxon church of St John in 1095. It was completed in 1115, burnt down in 1133, and then rebuilt in the early 13th century. A wall surrounding the ecclesiastical precinct had been built by the 13th century and further additions were made in the 14th and 15th centuries. The Abbey was dissolved in 1538, although historic maps indicate that many of its buildings remained standing well into the 17th century. The main gatehouse was built in the 15th century and still stands in the centre of the north side of the precinct wall, although much of it was rebuilt following the siege of Colchester of 1648 (CAT 2000). The magnificent Abbey gatehouse is a Grade I listed building and it and much of the area within and including the precinct wall is a Scheduled Monument. The south-western area within the Abbey precinct, within Area B1b closest to the Arena, is not part of the SM. However, as stated in the Environmental Statement (Atkins 2002) areas anywhere within the precinct could include domestic buildings belonging to the Abbey, the abbot's lodgings, guests' lodgings and gardens. Following a fire at the Garrison Officers Club building, evaluation trenching by CAT exposed extremely large robber trenches which indicate the site of the Abbey church.

2.18 The Abbey precinct wall survives along the full length of the eastern side of B1b along Mersea Road, and as a short section along the western edge against Flagstaff Road, whilst the southern

wall remains as a standing structure along the northern edge of the car park in the south-east area of B1b (with another short segment about 40m to the east).

- 2.19 The Roman circus greensand foundations were evidently systematically robbed during the medieval period, with material used for the construction/repair of the abbey and its precinct wall (circus derived greensand is still evident in the fabric of the abbey precinct wall flanking Flagstaff Road). Both C1 foundations and the C2 northern cavea and parts of the southern cavea footing were robbed in the medieval period, as was most of a monument base of the spina found beneath the cross roads of Flagstaff/Circular Road East and Napier Road/Circular Road North (see below). Spreads of mortar and demolition layer appear to have been associated with this activity.

f) Post-medieval

- 2.20 The post-dissolution Abbey grounds were under various owners after the 15th century, and were held by the Lucas family until the English Civil War. Maps between 1610 and 1648 show some buildings, including part of the church still standing within the precinct. Lucas's house is shown. Archaeological evidence for post dissolution activity at the site of St John's Abbey was located within a number of trial trenches for the residential development of Areas B1a and B1b (RPS 2015).
- 2.21 St John's Abbey precinct was used by Lucas as a fortified Royalist stronghold during the Parliamentary siege of Colchester in 1648. During the siege the Parliamentarians built a string of forts around the town linked by a substantial ditch and bank. A contemporary map (the 1648 Siege map of Colchester . see Fig. 10 of RPS 2015) indicates their probable alignment, although it contains some errors and inaccuracies which make any precise assessment impossible. Recent geophysical survey failed to locate the Parliamentary defences and the precise line of these fortifications had never been established. However, a large east-west post-medieval ditch of around the correct date was recently located within Area E1 (Fig. 1 - the new School site east of Circular Road East) (CAT forthcoming) and may be associated, in which case the defensive line ran south of the Arena through Abbey Field.
- 2.22 Nevertheless, part of a probable star-shaped fort ditch was subsequently identified within the north-west corner of Area A1 (former Hyderabad Barracks . Fig. 4) in 2010 and this may be the remains of one of the Siege of Colchester chain of forts labelled Fort Needham on the siege map. Alternatively, the fort represents a line of advancement as the siege progressed to the ultimate defeat of the Royalists. Notably another post-medieval ditch was found within the recently reconstructed northern Napier Road Car Park on the opposite side of Mersea Road (CAT 2014). This was aligned broadly east-west towards the A1 defined fort remains and possibly formed part of the westward line. If extrapolated further westwards it might extend close to the Arena area (although it was not identified by the C2 investigations).
- 2.23 The excavations at C1, C2 and Circular Road North/Napier Road exposed a number of post-medieval pits and ditches (e.g. 8 pits within C2) and similar presence of 17th-19th century features can be anticipated within the Arena site.

g) Modern/military

- 2.24 The map regression undertaken for the DBA (RPS 2015) indicates the location of the Arena Site was within the south-east corner of an agricultural field in the 17th and 18th centuries and by the later 19th century was located within the northern area of Colchester Garrison at Abbey Field. During World War II Area C2 of a track on the line of Circular Road East was used for lightly built military buildings, but the NAAFI (the Arena building) was not constructed until 1946 (CAT 2000).
- 2.25 The largest concentration of modern features within the vicinity of the Arena were found at Area C2 and comprise 23 pits, five service pipes/trenches, two drains, one soakaway and eight military features. Military features dated to the Second World War consisted of two trenches, four concrete air-raid bunkers, a communication trench (which linked three of the bunkers) and a square pit containing a stash of carefully stacked Home Guard petrol bombs ('Molotov Cocktails' which were safely removed by explosive ordnance specialists). The bunkers were 9.5m long, 2.5m wide, made with concrete slabs and had stairs at both ends and survived to a depth of approximately 1.22m (photo below). These military features are shown on Fig. 7 (also See CAT Report 319 for a more detailed report on the air-raid bunkers recorded on this site).

3 STRATEGY AND AIMS

- 3.1 This method statement is in accordance with the research design developed in consultation with CBC and complies with the guidelines laid down in Planning Policy Guidance on Archaeology and Planning (NPPF) and with the Chartered Institute of Field Archaeologists Standards and Guidance for Archaeological Evaluation (ClfA 2014). CAT (the contractor) will liaise closely with RPS (the Archaeological Project Managers and advisors to RMPA services c/o Fenn Wright) with respect to all important matters concerning the co-ordination and management of the project. The CBC archaeological officer (CBCAO) and Historic England will be kept fully informed of all archaeological developments.
- 3.2 All Stage 1a archaeological evaluation trenches will be monitored and signed off by the RPS Archaeological Project Manager and the CBCAO monitor prior to backfilling.
- 3.3 No reinstatement other than machine bucket compaction and tracking will be undertaken by the archaeological contractor and any waste materials will be stored on Site but not removed at this stage.
- 3.4 The general aim of the evaluation is to recover sufficient evidence to characterise the nature, date, function and importance of the archaeological features within the effected area. The overarching research themes, as stated in the research design are to:
- Inform how the landscape was used and to what level of intensification, prior to the construction of Camulodunum,
 - To elucidate the nature of spatial organisation within the oppidum
 - To address the question of the effect of the establishment of the Roman town on the agricultural hinterland.
 - Elucidate the presence/absence and if present relative density of Roman burials south of the Roman circus.
- 3.5 Specific Aims: The specific aims have to an extent been informed by the previous adjacent investigations as follows:
- To establish the presence/absence at the Arena Site of further Neolithic to Early Bronze Age activity potentially associated with pits, as previously found at Areas C1 and C2;
 - To establish the presence/absence at the Arena Site of further later Bronze Age/ earlier Iron Age activity potentially associated with features identified in Flagstaff Road and Circular Road North;
 - To establish presence/absence at the Arena Site of any Late Iron Age activity that might be associated with the Late Iron Age oppidum;
 - To identify presence/absence at the Arena Site of Roman cemetery evidence of the types seen at C2 or Abbey Field previously (NB these will only be excavated, in accordance a Ministry of Justice (formerly Home Office) licence in the event that they cannot be safely reburied for future excavation);
 - To identify presence/absence at the Arena Site of archaeological remains associated with the previously identified Roman pottery kiln);

- To identify presence/absence at the Arena Site of any further elements of the Roman to post-Roman landscape;
- To identify presence/absence at the Arena Site of any remains potentially associated with the Siege of Colchester offensive line; and
To identify presence/absence at the Arena Site of any activity associated with Colchester Garrison. .

3.6 The evaluation trenches are designed to identify presence/absence of archaeology of the types discussed above.

3.7 The CBC Archaeological Officer will require further Stage 1b trenching (post-determination) and mitigation works, depending on design.

4 METHOD STATEMENT

a) Trenching Evaluation

- 4.1 Machining protocols: Colchester Archaeological Trust (CAT) will provide a mechanical excavator and undertake the archaeological evaluation. CAT will require any known services that might be encountered by the trench positions as shown on Figure 2 to be notified to them by RMPA. The trenches will also be CAT scanned ahead of cutting as a further precaution.
- 4.2 A CAT archaeologist will observe the machining. Significant archaeological deposits will not be removed by machine unless sanctioned by the CBC Archaeological Officer (or in the case of the Roman circus by Historic England). In circumstances where vertical stratigraphy is found or where archaeology is vulnerable the machining will be monitored by a senior member of staff. Care will be taken to ensure that machines used do not rut, compact or otherwise damage buried or exposed archaeological features and deposits ahead of recording. No potentially significant archaeological deposits will be removed prior to recording and sampling (if necessary) to provide an adequate understanding of their character.
- 4.3 Surveying: Following the overburden stripping temporary bench marks will be surveyed with respect to an Ordnance Survey datum and all features and deposits will be recorded relative to their OD height. The TBM ϕ will be shown on the site location plans.
- 4.4 The exposed surface of the natural will be hand cleaned sufficiently to define any archaeological features present. This process will facilitate accurate planning and allow for metal detected finds to be correctly assigned following an initial scan of the site.
- 4.5 Complex areas (areas of intercutting features, surviving layers, where features are complex in form or where surface finds may be plotted) will be planned by hand, usually at a scale 1:20. These plans will be located via total station, scanned, vectorised and imported via CAT ϕ CAD programme on the OS grid-based plan. Less complex areas of the site (where features are absent or rare and of simple form) will be planned using a total station with the data input directly onto CAD and the OS tiles. There will be no site grid on the ground. All site plans will show OS grid points and spot levels and will be fully indexed and related to adjacent plans. It is not anticipated that single context recording will be appropriate. However, should particularly complex sequences of deposits or features be encountered, then single context recording will be undertaken. A uniform site plan will be produced showing all site features.

b) Sampling Strategy

- 4.6 Archaeological excavation will be by hand and will respect the stratigraphy of archaeological layers, features, deposits and structures. Each context will be excavated in sequence. Occasionally further use of the mechanical excavator may be required. Such techniques are only appropriate for the removal of homogenous low-grade deposits that may give a window into underlying levels. They will not be used on complex stratigraphy and the deposits to be removed must have been properly recorded first. If encountered horizontal deposits (e.g. layers) should be

hand excavated or sample excavated in 1m grid squares and should not be removed by machine.

- 4.7 The following sampling strategy will be adopted to ascertain the nature, depth, date and state of preservation of archaeological features as well as the stratigraphical relationships of these deposits and features to one another.
- (i) Normally 50% of the fills of all pits and other discrete archaeological features will be excavated. However, in the event that complex areas of pitting are encountered a representative sample will be excavated (although all will be planned). Tree throw holes will not normally be investigated.
 - (ii) At least 20% of the exposed lengths of ditches will be excavated. The segments will be placed to provide adequate coverage of the ditches and will include excavation of all terminals and intersections. A flexible approach will be adopted to the location of excavation samples such that areas of exposed ditch fill with higher artefact or ecofact content may be targeted. A lower excavation sample ratio of ditches will only be acceptable in the event that the research aims will not be further advanced. Any such reduction in sample ratio will be agreed with CBC and RPS.
 - (iii) At least 50% excavation of ring gullies will include excavation of the terminals and sections at each side to the rear of the gully. Special regard will be given to significant stratigraphical relationships and concentrations of artefactual material.
 - (iv) In the event that stone structures (beyond the circus) are encountered, these will be excavated in sufficient detail to establish their construction sequence and sequence of repairs or extensions. All stratigraphic associations will be recorded. Should floor levels (which are not anticipated) be encountered, these will be fully excavated and environmentally sampled.
 - (v) Sufficient investigation of hearths or kilns will be undertaken to determine their function and date. However, in the event such features are encountered they will be left in-situ for any resulting mitigation stage (i.e. if impacted).
 - (vi) Human burials, including cremations, will only be excavated at evaluation stage should they have been damaged by their exposure. In normal circumstances only sufficient work shall be undertaken at evaluation stage to identify whether burials are present. Any human remains identified, including cremations, will be left in-situ, covered and protected, unless otherwise directed. Human remains will normally only be excavated at subsequent mitigation stage after obtaining the relevant Ministry of Justice Licence, as required by the Burials Act of 1857 (amended 1981). The discovery of human remains will be reported to the local coroner. Other structured or placed deposits will be recorded and retained as ~~small finds~~. Should sufficient human bone be exposed to warrant specialist examination *in situ*, a human bone specialist may be required to attend to examine the remains (subject to CBCAO requirements).

- (vii) Metal detectors will be used to scan for metallic finds on spoil heaps, vacated areas, areas of modern disturbance and during the excavation of key archaeological features or deposits.

c) Recording

4.8 The following procedures will always be initiated:

- (i) All features will be planned either by means of a total station or hand drawn plans where appropriate.
- (ii) Sections: all sectioned and excavated archaeological features will be drawn at a scale of 1:20 or 1:10, or at a smaller scale (if appropriate). All sections will be levelled to ordnance datum.
- (iii) All archaeological features, layers or deposits will be allocated unique context numbers prior to any hand excavation including contexts for which there is no archaeological interpretation or definition. All archaeological features, layers or deposits will be recorded on pro-forma context sheets detailing: character, contextual relationships, a detailed description, associated finds, interpretation and cross referencing to the drawn, photographic and finds records. On-site matrices will be compiled during the excavation such that the results of the written stratigraphical records may be fully analysed and phased.
- (iv) An adequate photographic record of the investigation will be made of all archaeological features and deposits. Standard record shots of contexts will be taken on a digital camera. The record will include working and promotional shots to illustrate more generally the nature of the archaeological operations. All photographic records will include information detailing: site code; date; context(s); section number; a north arrow and a scale. All photographs will be listed and indexed on context record sheets.
- (v) A record of the full extent in plan of all archaeological features, deposits or layers encountered will be produced. The detailed hand drawn plans will be related to the site, and O.S. national grid and be drawn at an appropriate scale, generally 1:20. Where necessary e.g. when recording an inhumation, additional plans at 1:10 scale, or where appropriate 1:20 will be drawn. The O.D. height of all principal strata and features will be calculated and indicated on the appropriate plans and sections.
- (vi) A record or index will be maintained of all site drawings and these will form part of the project archive. All site drawings will contain the following information: site name; site number and code; scale; plan or section number; orientation, date and compiler.

d) Treatment of Samples

4.9 Industrial residues will be recorded and sampled in accordance with the Society of Museum Archaeologists (SMA, 1993) guidelines. The presence of such residues will always be recorded and quantified fully, even where comprehensive retention is considered to be inappropriate. Large technological residues will be collected by hand. Separate samples (c.10ml) will be collected where appropriate for identification of hammer scale and spherical droplets. The advice provided in the Historic England/ Metallurgy Society document Archaeometallurgy in

archaeological projects, will be referred to. Structural remains will be similarly recorded in accord with the SMA guidelines.

- 4.10 The environmental sampling policy is as follows. CAT is advised by the Historic England Regional Advisor in Archaeological Science. In consultation with Val Fryer, CAT will bulk sample any potentially rich environmental layers or features in addition to all reliably dated deposits. These will be assessed by VF, and future sampling policy on other excavations areas will follow her advice. If any complex or outstanding deposits are encountered, then JM and/or VF will be asked onto site to advise. Pollen is not expected to survive within these soils, but should deep deposits with pollen preservation potential be encountered column samples will be retrieved for laboratory analysis.
- 4.11 In addition to retrieving environmental evidence (above), bulk sampling will be used to collect charcoal for potential C14 dating.
- 4.12 The procedures set in A guide to sampling deposits for environmental analysis (Murphy and Wiltshire 1994) and Environmental Archaeology . A guide to the theory and practice of methods, from sampling and recovery to post-excavation (English Heritage Centre for Archaeology Guidelines 2002) will be consulted. The following procedures will be followed unless otherwise amended following consultations between RPS, the Historic England Advisor in Archaeological Science, the bioarchaeologist and the Site Director:
- (i) 40 litre bulk samples (or 100% of smaller contexts) of anthropogenic concentrations will be taken and of selected deposits where remains are not visible (but may nevertheless occur). These shall include well sealed deposits, floors, hearths etc.
 - (ii) Monoliths for pollen analysis will be taken as appropriate to answer specific research questions.
 - (iii) 30 litre bulk samples will be taken (if possible) from a selected sample of closely dated pits. These deposits will be sampled regardless of whether or not there are visible macrofossils or molluscs.
 - (iv) Whole fill samples from a selection of post-holes of definable structures will taken for assessment.
 - (v) Cremations and other special deposits will be 100% sampled and sieved for the retrieval of remains.
 - (viii) 100% recovery of animal bones will be undertaken from the soil samples. It is possible that 100 litre samples for bone may also be necessary in some circumstances.

e) General Methodology

- 4.13 All works will be undertaken by a team of professional archaeologists. The proposed team structure is given in the appendix (end of document).
- 4.14 All work will be according to CAT Policies and Procedures (2000), and will be informed by Management of Archaeological Projects (English Heritage 1991), and Guidelines on Standards

and Practices for Archaeological Fieldwork in the Borough of Colchester (Colchester Borough Council 1996, revised 1999).

- 4.15 Animal and human burials, including cremations, will only be excavated should they have been damaged by their exposure. A Ministry of Justice (MOJ) licence is required for the excavation of human remains. Where a licence for their excavation is issued by the MOJ, the requirements of that licence will be followed.
- 4.16 All finds of potential treasure will be removed to a safe place, and the coroner informed immediately, in accordance with the rules of the Treasure Act 1996. The definition of treasure is given in pages 3-5 of the Code of Practice of the above act. This refers primarily to gold or silver objects.
- 4.17 For purposes of deposition of the archive, a museum accession code will be obtained through Colchester Museum. This will be used this as the site code.
- 4.18 The Code of Conduct of the Chartered Institute of Field Archaeologists (CIFA) will be followed.
- 4.19 Following completion of the manual excavation and recording the trenches will be backfilled flush with ground level. There are no proposals to reinstate the surfaces with simple backfilling of trenches the agreed method.
- 4.20 Industrial residues will be recorded and sampled in accordance with the Society of Museum Archaeologists (SMA, 1993) guidelines. The presence of such residues will always be recorded and quantified fully, even where comprehensive retention is considered to be inappropriate. Large technological residues will be collected by hand. Separate samples (c.10ml) will be collected where appropriate for identification of hammer scale and spherical droplets. The advice provided in the English Heritage/ Metallurgy Society document Archaeometallurgy in archaeological projects, will be referred to. Structural remains will be similarly recorded in accord with the SMA guidelines.
- 4.21 The environmental sampling policy is as follows. CAT is advised by the East of England Historic England Regional Advisor in Archaeological Science (Dr Zoe Outram). In consultation with Val Fryer, CAT will bulk sample any potentially rich environmental layers or features in addition to all reliably dated deposits. These will be assessed by Val Fryer, and future sampling policy on other excavations areas will follow her advice. If any complex or outstanding deposits are encountered, then the of England Historic England Regional Advisor in Archaeological Science and/or Val Fryer will be asked onto site to advise. Pollen is not expected to survive within these soils, but should deep deposits with pollen preservation potential be encountered column samples will be retrieved for laboratory analysis.
- 4.22 In addition to retrieving environmental evidence (above), bulk sampling will be used to collect charcoal for potential C14 dating.
- 4.23 The procedures set in '*A guide to sampling deposits for environmental analysis*' (Murphy and Wiltshire 1994) and '*Environmental Archaeology – A guide to the theory and practice of methods, from sampling and recovery to post-excavation*' (English Heritage Centre for Archaeology Guidelines 2002) will be consulted. The following procedures will be followed unless otherwise

amended following consultations between RPS, the Historic England Advisor in Archaeological Science, the bioarchaeologist and the Site Director.

- (i) 40 litre bulk samples (or 100% of smaller contexts) of anthropogenic concentrations will be taken and of selected deposits where remains are not visible (but may nevertheless occur). These shall include well sealed deposits, floors, hearths etc. A representative range of features should be sampled and environmental sampling should include undated, as well as dated, archaeological contexts.
- (ii) Monoliths for pollen analysis will be taken as appropriate to answer specific research questions.
- (iii) 40 litre bulk samples will be taken (if possible) from a selected sample of closely dated pits. These deposits will be sampled regardless of whether or not there are visible macrofossils or molluscs.
- (iv) Whole fill samples from a selection of post-holes of definable structures will taken for assessment.
- (v) Any excavated cremations and other special deposits will be 100% sampled and sieved for the retrieval of remains.
- (vi) 100% recovery of animal bones will be undertaken from the soil samples. It is possible that 100 litre samples for bone may also be necessary in some circumstances.

5 PUBLIC ARCHAEOLOGY

- 5.1 Public access will not normally be provided to the trenches although the archaeological works will be visible from adjacent public areas.

6 HEALTH AND SAFETY

- 6.1 CAT will provide a Risk Assessment for the project for RMPA Services prior to the commencement of the works.
- 6.2 All the latest Health and Safety guidelines will be followed on site. CAT has a standard safety policy (CAT 2008), which will be adhered to.
- 6.3 No personnel will work in deep or unsupported excavations. The sides of all excavations or trenches deeper than 1.2 metres will be stepped or battered. Due to the difficulty of working in shored trenches, shoring will be avoided wherever possible. Safety helmets will worn by personnel in deep trenches or other potentially unsafe positions. All deep trenches shall be fenced off and will be clearly indicated by %deep excavation+signs.
- 6.4 The archaeologist(s) will not enter an area under machine excavation without alerting the machine driver to his/her intention.
- 6.5 The archaeologist(s) shall remain alert and take due care not to impede the progress of moving machinery. He/she shall stand well back from the turning circle of an excavatorqbuckets and cabs.
- 6.6 Spoil will be stored at a safe distance away from trench edges.
- 6.7 Suitable accommodation will be provided for staff to shelter from inclement weather and during breaks. Hand washing facilities will be provided.
- 6.8 CAT will provide any necessary protective footwear, high-visibility jackets, and safety helmets. All staff and visitors to the site will be expected to wear full PPE at all times.
- 6.9 The RPS project manager will be provided with a list of all personnel working on site each day by the CAT Supervisor.
- 6.10 CAT scanning will be undertaken prior to and during machine excavation.

7 FINDS

- 7.1 Unstratified finds will only be collected where they contribute significantly to the research aims or are of intrinsic interest. All finds will be exposed, lifted, cleaned, conserved, marked, bagged and boxed according to the United Kingdom Institute for Conservation's Conservation Guidelines No.2, the Council for British Archaeology's First Aid for Finds (Third Edition, 1998) and the Institute of Field Archaeologists's Guidelines for Finds Work (1992). Iron finds may require X-rays prior to conservation and similarly residues on pottery may require study ahead of any conservation which may be appropriate.
- 7.2 All finds and bones will be recorded, collected and labelled according to their individual stratigraphical context. Finds from each archaeological context will be allocated an individual finds tray and waterproof labels will be used for each tray to identify unique individual contexts. Each label will be marked with the appropriate context number in waterproof ink and will be securely attached to each tray.
- 7.3 A policy of marking for pottery and other finds will be agreed with Colchester Museum. Marking will include the site code and context number.
- 7.4 All lifting, conservation or other on-site treatment of delicate finds will be done by Anne-Maria Bojko of Colchester Museums. It is anticipated that robust items such as intact cremations will be lifted by site staff.
- 7.5 The site archive will be presented to Colchester Museums in accordance with the requirements for conservation and storage as outlined in Guidelines on the Preparation and Transfer of Archaeological Archives to Colchester Museums (Colchester Borough Council 1996).
- 7.6 All finds of potential treasure will be removed to a safe place, and the coroner informed immediately, in accordance with the rules of the Treasure Act 1996. The definition of treasure is given in pages 3-5 of the Code of Practice of the above act. This refers primarily to gold or silver objects. Any other finds remain for the landowner to assess and dispose of.
- 7.7 Finds work will be to accepted professional standards and adhere to the Chartered Institute for Archaeologists's published booklet Guidelines for Finds Work.
- 7.8 Agreement with the landowner will be sought for deposition of the finds and paper archive. Arrangements for the finds to be viewed by the landowner will be made if he/she wishes.
- 7.9 The following specialists have been approached for artefact and environmental analysis:
- Francesca Boghi . Human Bone
 - Susan Curle - animal bone;
 - Paul Sealey . prehistoric pottery
 - Stephen Benfield late Iron Age and Roman pottery;
 - Joanna Bird - Samian
 - Laura Pooley/Ernest Black . Roman Brick/tile
 - Dr Hilary Cool . Roman glass

- Dr John A Davies . Roman coins
- Nina Crummy . Small finds
- Sue Tyler- Saxon Pottery
- Helen Walker . Medieval and Post-Medieval pottery
- Hazel Martingell - Lithics
- Lynn Keys . Metalworking residues;
- Pat Wiltshire- pollen analysis
- Peter Murphy - Environmental
- Val Fryer- Archaeo-botanist
- Jackie Makinley- Cremations.

8 REPORTING

- 8.1 At the start of work an OASIS online record <http://ads.ahds.ac.uk/project/oasis/> must be initiated and key fields completed on Details, Location and Creators forms. When the project is completed, all parts of the OASIS online form must be completed and a .pdf version of the entire report should be uploaded to the OASIS website. A copy of the OASIS online form should be included as an appendix to the report. A copy of the WSI should be included as an appendix to the report.
- 8.2 Following completion of trenching an archaeological evaluation report will be completed within 4 weeks of the completion of works and submitted to RPS Planning for distribution to the CBCAO and Historic England for their approval.
- 8.3 Expert advice and reporting (in relation to cultural artefacts and ecofacts) will be provided by individual Specialists appointed as appropriate.
- 8.4 All records and materials will be compiled in a structured archive in accordance with the guidelines of Appendix 3 in the Historic England procedural document, Management of Archaeological Projects (1991).
- 8.5 The MoRPHE Project Managers Guide (EH 2006) will be adhered to with regard to post-excavation management in relation to this and any subsequent mitigation that may be required.
- 8.6 If further mitigation is required, publication in local or national journals appropriate to the results will be considered. Minimum publication will consist of a note in a local archaeological journal.
- 8.7 An unbound hardcopy of the report (or grey literature report if otherwise agreed), clearly marked DRAFT, will be presented to the CBCAO for scrutiny. Following acceptance, a single digital and hard copy of the report should be presented to both the Colchester UAD and Essex HER. A hard copy of the report should be deposited with the archive at Colchester and Ipswich Museum.
- 8.8 Copies of the final report will also be issued to the RPS, RMPA Services and Historic England.
- 8.9 The report should include relevant background context information as provided within the desk-based assessment (RPS 2015) including historic maps to demonstrate (changes to) the recent, post-medieval, land use of the site and its context.
- 8.10 At the end of the project, a copy of the digital vector plan, which must be compatible with MapInfo GIS software, will be sent by CAT to CBC for integration in the UAD. Files should be exported and saved into a format that can be imported into MapInfo (for example, as a .dxf or .TAB files).

a) Publication

- 8.11 Depending on the significance of findings and the recommendations of any required assessment the results may be included within the final publication of the closely related Garrison project. However, this eventuality is unlikely to be based on this evaluation alone and a full publication proposal will be drawn together in accordance with any subsequent evaluation/mitigation works that may be required for this Site in due course.

9 ARCHIVE AND FINDS DEPOSITION

- 9.1 All retained artefacts will be cleaned, conserved and packaged in accordance with the requirements and guidelines of the United Kingdom Institute for Conservation, Conservation Guidelines No. 2, the Council for British Archaeology, First Aid for Finds (Second Edition, 1987), the Chartered Institute for Archaeologists, Guidelines Standard and guidance for the creation, compilation, transfer and deposition of archaeological archives Published December 2014. Small finds will be boxed separately from the bulk finds. Plans will be presented on hanging strips to fit Colchester Museum storage systems. A full archive will be prepared to standards outlined in Management of Archaeological Projects: 2 (English Heritage 1991).
- 9.2 The full archive will be deposited at Colchester Museums, subject to RMPA Services Plc consent and subject to the guidelines and requirements of MAP 2, as soon as is practicable, and within six months of completion of publication text on the project. All requirements for archive storage as given in Colchester Borough Council, Guidelines for the standards and practice of archaeological fieldwork in the Borough of Colchester, will be followed.
- 9.3 Finds (and other retained materials) will be bagged and boxed in the manner recommended by Colchester Museums.
- 9.4 Photographic archive is to be presented as follows: original digital data on CD Roms, hard copies of digital photos on high quality paper, or as otherwise requested by Colchester Museums.
- 9.5 CD Roms of material held on computers will be presented to Colchester Museums, along with bound copies of printouts.
- 9.6 Deposition of the archive will be confirmed in writing to CBCAO, and a summary of the contents of the archive shall be supplied to CBCAO.
- 9.7 All artefacts recovered from the archaeological excavation shall be deposited at the Colchester Museums. All recovered artefacts shall be fully catalogued, shall constitute one single deposit and shall be deposited within two years of the completion of the archaeological excavation.

10 STAFFING AND TIMETABLE

- 10.1 The overall archaeological project will be managed by Robert Masefield CMIfA (RPS). The archaeological contractor CAT will be managed by Philip Crummy CMIfA. The evaluation will be directed in the field by Ben Holloway and/or Chris Lister. The experience of the project team is included in the Appendix of this method statement.
- 10.2 A total of approximately 5 days with a full CAT team to investigate the trenches, with a further 2 days to backfill, is currently envisaged.
- 10.3 The work is currently programmed to begin on 27th April 2015.

11 MONITORING

- 11.1 A programme of monitoring of the project in the field shall be agreed in advance between CAT, RPS, RMPA Services/Fenn Wright, Historic England (as appropriate) and CBC.
- 11.2 Any variation or modification to the project programme in terms of working or recording either on site or off will be fully discussed and agreed with RPS, RMPA Services/Fenn Wright, Historic England (as appropriate) and CBC in advance.
- 11.3 Any variations of the WSI shall be agreed between RPS, RMPA Services/Fenn Wright, CBCAO, Historic England and CAT prior to their being carried out.
- 11.4 The involvement of CBCAO and the Historic England officer shall be acknowledged in any report or publication generated by this project.

12 REFERENCES

1. Association of County Archaeological Officers 1993 Model clauses on Archaeological Briefs and Specifications
2. Atkins October 2000 MoD Colchester Garrison PFI: Composite Environmental Statement
3. Bedwin, O. (eds) 1991. The Archaeology of Essex- Proceedings of the Writtel Conference. Essex County Council Planning.
8. Benfield, S., Black, E., Crummy, N., Fryer, V., and Wade, A. 2000. Archaeological excavations at the Garrison sports pitch, Circular Road North, Colchester, Essex (Abbey Field). CAT Report 138.
9. Brickley, M and McKinley, J. (eds). 2004. Guidelines to the Standards for Recording of Human Remains. Reading: British Association for Biological Anthropology and Osteoarchaeology/Institute of Field Archaeologists.
11. Brown, N.R. 1996. In Bedwin, O. (eds) The Archaeology of Essex- Proceedings of the Writtel Conference. Essex County Council Planning.
19. Brown, N.R. and Murphy, P.L. 1997. In Glazebrook J. (eds) Research archaeology: a framework for the Eastern Counties 1. Resource assessment. East Anglian Archaeology, Occasional Paper, 3.
20. Brown, N.R. and Glazebrook (eds), 2000. Research and archaeology: a framework for the Eastern Counties 2. Research agenda and strategy. East Anglian Archaeology, Occasional Paper, 8.
21. Brown, N.R. and Murphy, P.L. 2000. 'Neolithic and Bronze Age', in N.R Brown and J. Glazenbrook (eds) Research and Archaeology: A Framework for the Eastern Counties, 2. Research Agenda and Strategy (East Anglian Archaeology Occasional Paper No.8), 9-13. Norwich.
22. Bryant 1997. In Glazebrook J. (eds) Research archaeology: a framework for the Eastern Counties 1. Resource assessment. East Anglian Archaeology, Occasional Paper, 3.
27. Buikstra, J. E. and Ubelaker, D. H. 1994. Standards for Data Collection from Human Skeletal Remains. Arkansas Archaeological Survey Research. Series 44.
29. CAR 9 Excavations of Roman and later cemeteries, churches and monastic sites in Colchester, 1971-88, by Colchester Archaeological Report, 9 (1993)
30. Charlton, B & Mitcheson, M. 1984. The Roman Cemetery at petty Knowes, Rochester, Northumberland. Archaeologia Aeliana Fifth Series, Volume XII. The Society of Antiquaries of Newcastle Upon Tyne MCMLXXXIV.
31. ClfA 2014. Standard and guidance for the creation, compilation, transfer and deposition of archaeological archives. Published December 2014
32. ClfA 2014 Standard and guidance Archaeological Field Evaluation. Published December 2014

33. CLG 2010, PPS 5, Planning for the Historic Environment: Historic Environment Planning Practice Guide
34. Colchester Archaeological Trust, 1999 (revised Feb 2000) Policies and Procedures.
35. CAT (revision of Aug1999) Site Safety Policy
36. Colchester Archaeological Trust, 2000. An archaeological desk-based assessment of the Colchester Garrison PFI site (CAT Report 97).
37. Colchester Archaeological Trust 2001 Archaeological excavations at the Garrison sports pitch, Circular Road North, Colchester, Essex (Abbey Field), by Carl Crossan, Colchester Archaeological Trust Archive Report, 138 (2001)
38. Colchester Archaeological Trust, 2002. Colchester Garrison redevelopment: method statement and risk assessments for archaeological fieldwalking survey, geophysical survey and evaluation trenching.
39. Colchester Archaeological Trust, May 2002. An Archaeological Evaluation by Fieldwalking and Geophysical Survey at Colchester Garrison PFI site, Colchester, Essex (CAT Report 184).
40. Colchester Archaeological Trust, June 2005. A survey of a group of air-raid shelters at Area C2 of the Garrison Urban Village, Napier Road, Colchester, Essex: April-May 2004 (CAT Report 319).
47. Colchester Archaeological Trust, July 2005. The Colchester Garrison PFI Project, Colchester, Essex: a report on the 2003 excavation of Areas 2, 6 and 10: August-November 2003 (CAT Report 292). Produced in association with RPS.
48. Colchester Archaeological Trust in association with RPS, 2006 Assessment Report on the Archaeological Investigations carried out on Areas C1, C2, E, J1, O, Q and S1 of the Alienated Land, Colchester Garrison, including the Time Team Trenches and the Alienated Land Watching Brief. Report prepared by Laura Pooley, Ben Holloway, Philip Crummy and Rob Masefield
49. Colchester Archaeological Trust, June 2005. A survey of a group of air-raid shelters at Area C2 of the Garrison Urban Village, Napier Road, Colchester, Essex: April-May 2004 (CAT Report 319).

Colchester Archaeological Trust in association with RPS, October 2007. An archaeological excavation on the Abbey Field car park, Circular Road North, Colchester, Essex. January to February 2007 (CAT Report 424). H. Brooks, B. Holloway and R. Masefield.
50. Colchester Archaeological Trust, 2011. Archaeological Investigations on the Alienated Land Colchester Garrison, Colchester, Essex. May 2004-October 2007. Report prepared by Pooley, L, Crummy, P, Shimmin D, Brooks, H, Holloway, B and Masefield R. February 2011 (CAT Report 412)
51. Colchester Borough Council, 1996 (revised 2002). Guidelines on the standards and practice for archaeological fieldwork in the Borough of Colchester.
52. Colchester Museums (Colchester Borough Council) 1996 Guidelines on the Preparation and Transfer of Archaeological Archives to Colchester Museums

55. Crummy, N., Crummy, P., and Crossan, C. 1993. Excavations of Roman and Later Cemeteries, Churches and Monastic Sites in Colchester, 1971-88 (Colchester Archaeological Report 9). Colchester.
60. Crummy, P. 1997. City of Victory: the story of Colchester . Britain's first Roman town. Colchester Archaeological Trust.
63. Drury, P. J. 1978. Excavations at Little Waltham, 1970-71. Council for British Archaeology, Research Report, 26.
68. English Heritage, 1991. Management of Archaeological Projects.
69. English Heritage, 2006. Management of Research in the Historic Environment. The MoRPHE Project Managers Guide
76. English Heritage, 2002. Environmental archaeology . a guide to the theory and practice of methods, from sampling and recovery to post-excavation. Centre for Archaeological Guidelines.
77. Glazebrook, J. (eds) 1997. Research archaeology: a framework for the Eastern Counties 1. Resource assessment. East Anglian Archaeology, Occasional Papers, 3.
79. Gurney, D. (eds) 2003. Standards for field archaeology in the East of England. East Anglian Archaeology, Occasional Papers, 14.
81. Hawkes, C. F. C and Hull, M. R. 1947. Camulodunum (Reports of the Research Committee of the Society of Antiquaries of London No.14). London.
85. Hawkes, C. F. C. and Crummy, P. 1995. Camulodunum 2 (Colchester Archaeological Report No.11) Colchester.
86. Hull, M. R. 1958. Roman Colchester. Reports of the Research Committee of the Society of Antiquaries of London, no.XX.
91. Humphrey, J. 1987. Roman Circuses: arenas for chariot racing.
92. Mays, S., Brickley, M. and Dodwell, N. 2002. Human Bones from Archaeological sites. Guidelines for Producing Assessment Documents and Analytical reports. (Centre for Archaeology Guideline). Swindon: English Heritage.
100. Murphy, 1996. In Bedwin, O. R. (eds) The Archaeology of Essex - Proceedings of the Writtel Conference. Essex County Council Planning.
101. Murphy and Wiltshire, 1994. A guide to sampling deposits for environmental analysis.
102. Pooley, L, Crummy, P, Shimmin D, Brooks, H, Holloway, B and Masefield R. 2011. Archaeological Investigations on the Alienated Land Colchester Garrison, Colchester, Essex. May 2004-October 2007. CAT Report 412, February 2011
106. RPS 2002 Colchester Garrison PFI archaeological project strategy proposal

109. RPS and CAT, 2004. Research design for archaeological evaluations, excavations and watching briefs on Alienated Land, New Garrison, Colchester.
111. RPS 2015. Proposed development at the Arenaq Colchester. An Archaeological baseline appraisal prepared on behalf of RMPA Services
121. Shimmin, D., 1998. A Late Iron Age and Roman occupation site at Kirkee McMunn barracks, Colchester Essex. Essex Archaeology and History, vol 29, pp 260-269.
122. Society of Museum Archaeologists, 1993. Guidelines for Samples.
124. Wilkinson, DE and Neal V. (CBA) 1987 (Third ed. 1998) First Aid for Finds

APPENDIX 1

Team Structure

RPS PROJECT MANAGEMENT TEAM

Archaeological Project Manager

Rob Masefield

LIST OF CAT TEAM MEMBERS

Project Management

Philip Crummy

Howard Brooks

Site Manager

Ben Holloway

Site staff

C. Lister, A Wightman, E Spurgeon, AN Others.

Finds

E Spurgeon

Metal detecting

Brian Hurrell

Finds Consultants

Stephen Benfield (CAT) LIA/Roman pottery

Joanna Bird (Guildford) Samian ware

Ernest Black (Colchester) Roman brick/tile

Paul Sealey Prehistoric Pottery/ amphora

Hilary Cool (Nottingham) Roman glass

Nina Crummy (Colchester): Small finds

Julie Curle (Sylvanus: Archaeological, Natural History and Illustration Services) Human and Animal bone.

John Davis (Norwich Museum) Roman coins

Val Fryer (Loddon) Environmental processing

Nick Lavender (ECC) Prehistoric pottery

Hazel Martingell (Braintree) Lithics

Rachel Ballantyne (EH) Environmental policy

Valerie Rigby (British Museum) LIA ceramics

Paul Sealey (Colchester Museums) Roman Amphoras

Susan Tyler (ECC) Saxon Pottery

Helen Walker (ECC) post-Roman pottery.

Graphics

C Lister, E Spurgeon, J Chittenden, H Brooks

Report writing

B, Holloway, H Brooks,

RPS EXPERIENCE

Robert Masefield

Office: Cottons Centre, London Bridge

Position in Company: Director

Qualifications / Memberships: FSA, CMIFA, MA, BSc

Date of Birth: 15 October 1969

Key Clients: Taylor Wimpey, RMPA Services, Southern Water, Cemex UK, Countryside Properties, Gatwick Airport Limited

Robert has over 20 years experience in British archaeology and has been with RPS for ten years. He has recently transferred to the London office. Experienced in the production of Environmental Impact Assessments and Statements, the design and management complex archaeological projects and the preparation of proofs of evidence, he also has extensive experience of undertaking negotiations on behalf of clients.

Experience Includes:

- Delivery of compliance with Town and Country Planning, Ancient Monuments, Conservation Area and Listed Building legislation, Environmental Impact Assessment (EIA) and Construction Design Management (CDM) regulations; and the Highways Agency Design Manual for Roads and Bridges (DMRB vol 10 & 11)
- Provision of Environmental Statement chapters including Great Western Park (George Wimpey & Taylor Woodrow), Colchester New Garrison (RMPA/ MoD) Didcot, Radcot Farm Mineral Extraction (Oxfordshire), Priors Green, Takeley (Countryside Properties), The Wixams, Elstow, Bedfordshire (National Power/JJ Gallagher), Barrington Quarry, Cambridgeshire (Cemex), Sheerness WTM (Peel Ports), plus several ES's on behalf of Southern Water (Bognor, Littlehampton, Bexhill & Hastings and Brighton & Hove).
- Project Design and Management on watching briefs evaluation and excavation projects including production of written schemes of investigation and Research Agendas.

Management and design of the 160ha Colchester New Garrison and linked Urban Village projects including identification and successful retention within the scheme of Britain's first Roman circus, excavation of major cemetery site and excavation of prehistoric and Roman sites within Camulodunum.

DETAILS OF CAT TEAM MEMBERS

SENIOR SITE STAFF

Philip Crummy MA, FSA, MIFA

Philip is a very experienced field archaeologist, and the longest-serving director of excavations at any major archaeological organisation in Britain. Since joining CAT (or Colchester Excavation Committee as it was then, and Colchester Archaeological Unit soon after) as Site Director in the early 1970s, he has supervised or directed large urban projects including Lion Walk, Balkerne Lane, Butt Road, and Culver Street, as well as numerous small projects. Philip's publication record is outstanding, and includes sole or joint authorship of eight of the Colchester Archaeological Report series, principally volumes 1, 3, 6, 9, and 11. He also produces major parts of the CAT annual magazine *The Colchester Archaeologist*. He has also contributed to *Britannia*, *Post-medieval Archaeology*, and several of the BAR series. His most recent work *City of Victory* is one of the local bestsellers in bookshops in Colchester. He lectures widely.

Stephen Benfield BA, Cert Archaeol (Oxon) (CAT)

After working in farming Banking, Estate Agency, and in a Jobcentre, Stephen discovered archaeology. His first involvement with Colchester archaeology was in 1985, working on a Manpower Services Commission sponsored project, assisting in processing the enormous collection of Roman pottery from excavations in the town. After that he studied for his post-graduate Certificate in Archaeology at Oxford. Returning to CAT, he has since worked on many CAT projects at various supervisory and directorial positions, including the major projects at Stanway Iron Age burial site and Gosbecks Roman temple/theatre complex. Stephen has also, through much hands-on experience, built up a considerable working knowledge of LIA and Roman ceramics. He now completes ceramic assessments and full reports for CAT, drawing on the unrivalled catalogues provided by the standard Colchester works *Camulodunum* (Hawkes & Hull 1947), *Roman Colchester* (Hull 1958) and now CAR 10, and by examining the fabric series held at CAT headquarters.

Ben Holloway BSc AIFA

Ben joined CAT staff in June 2000, a graduate in Archaeology from Bournemouth University. Ben has conducted fieldwork in Scotland and the Isle of Man. Since joining the Trust Ben has carried out extensive work in Colchester at various supervisory and project positions including evaluations and excavations at Colchester Garrison PFI (including the circus), St Marys Hospital and Colchester 6th Form College. His work in Essex includes the Sandon Park and Ride Site, Skyline 120 Business Park at Great Notley, Dry Street, Basildon and the Stanhope industrial park Stanford-le-hope.

FINDS SPECIALISTS

Joanna Bird FSA (Guildford) Samian

Joanna is one of the country's top Samian specialists. Among her large corpus of work is a contribution to the blockbuster Colchester Archaeological Report 10: Roman pottery from excavations in Colchester 1971-86.

Ernest Black (Colchester) Roman brick/tile

Ernie is a Colchester schoolteacher with a wide interest in archaeology and the classical world. In this sense, he is following in the footsteps of A.F. Hall and Mike Corbishley who were also local schoolmasters. He has developed his specialism by large scale hands-on experience with Roman brick and tile, and has contributed to the Archaeological Journal Colchester Archaeological Report 6: Excavations at Culver Street, the Gilbert School, and other sites in Colchester 1971-85.

Dr Hilary Cool FSA MIFA (Nottingham) Roman glass

Yet another graduate of the University of Wales, Hilary is now a freelance glass and finds specialist, and has written many reports on glass from Colchester sites, including contributions to Colchester Archaeological Report 6: Excavations at Culver Street, the Gilbert School, and other sites in Colchester 1971-85, and Colchester Archaeological Report 9: Excavations on Roman and later cemeteries, churches and monastic sites in Colchester 1971-88 (1993). Among her major works is the internationally selling Colchester Archaeological Report 8: Roman vessel glass from excavations in Colchester 1971-85.

Nina Crummy (Colchester) Small finds

Nina first worked in the early 1970s as finds assistant on the major urban excavations in Colchester for the Colchester Excavation Committee (later the Trust). Over the next twenty years she built up an unrivalled working knowledge of small finds of all types. She has collaborated in most of the Colchester Archaeological Reports, and was principal author of the best-selling Colchester Archaeological Reports 2 (Roman small finds), 4 (The coins from excavations in Colchester 1971-9) and 5 (The post-Roman small finds from excavations in Colchester 1971-85). She recently worked for the Museum of London, and was instrumental in the recent transfer of and the massive improvement in accessibility to archaeological archives in London. She now works freelance on small finds reports for CAT, HBAS, and other bodies including Winchester Excavation Committee.

Julie Curle (Sylvanus: Archaeological, Natural History and Illustration Services) Human and Animal Bone

Julie has over 16 years of experience in archaeology and in particular finds for the Norfolk Archaeological Unit and Norfolk Museums Service. Currently working as a freelance specialist in both human and animal bone and illustration. She has been producing faunal and Human remains reports for many years and produces assessment and analysis reports for clients across the East Anglian region. She has her own extensive bone reference collection built up over many years. Her particular interests in faunal remains are animal husbandry and pathologies. She has also worked as a conservator, particularly on Pleistocene vertebrates and a wide variety of

archaeology and natural history projects at the Norwich Castle Museum. Julie is also an extra-mural lecturer with the University of East Anglia, teaching Animal bones in Archaeology.

Dr John A Davies (Norwich Museum) Roman coins

John has, for some years, written reports on Roman coins from Colchester excavations. He specialises in barbarous radiates, and has contributed to British Numismatic Journal on that topic. Among his other publications is a contribution to Colchester Archaeological Report 4: The coins from excavations in Colchester 1971-9, and Colchester Archaeological Report 9: Excavations on Roman and later cemeteries, churches and monastic sites in Colchester 1971-88 (1993).

Nick Lavender (to follow)

Hazel Martingell BA, FAAIS (Braintree): Lithics

Hazel has for many years worked as a lithics illustrator and specialist, undertaking work for The British Museum, ECC Field Archaeology Unit and for London and Cambridge Universities, to name but a few. Since 1987 she has been self-employed and has excavated at a Middle Stone Age site at Gorham Cave, Gibraltar as well as writing and illustrating worked flint reports for CAT, ECC FAU, and the British Museum. Her impressive publication record includes reports on sites from around the globe. Closer to home she has published work in *Essex History and Archaeology*, The *East Anglian Archaeology* Monograph series, *Antiquity* and *British Museum Occasional Papers*. Hazel is a fellow of the Association of Archaeological Illustrators and Surveyors and a founder member of the Lithics Study Group, London.

Rachel Ballantyne (EH) Environmental (to follow)

Valerie Rigby (British Museum) LIA ceramics

Val is one of the country's leading authorities on later prehistoric ceramics in general, and traded wares in particular. She has published widely. Her major work include Baldock: the excavation of a Roman and pre-Roman settlement, 1968-72 (Britannia Monograph Series 7, with Ian Stead). On a more local level, she has contributed to the magisterial Colchester Archaeological Report 10: Roman pottery from excavations in Colchester 1971-88, and to Ros Niblett's Sheepen: an early Roman industrial site at Camulodunum (Council for British Archaeology Research Report 57, 1985).

Dr Paul Sealey (Colchester Museums) Amphoras/prehistoric pottery

Paul has worked at Colchester Museum since the late 1970s. His PhD specialism was Roman amphoras, a topic on which he writes specialist reports for Colchester sites. His main areas of interest are prehistory and the Roman period, and he has developed a familiarity with those periods and their ceramics. He has published widely. His major works include Amphoras from the 1970 excavations at Colchester Sheepen (British Archaeological Report 142, 1985), contributions to Ros Niblett's Sheepen: an early Roman industrial site at Camulodunum (Council for British Archaeology Research Report 57, 1985). He regularly contributes to Essex Archaeology & History.



FIGURE 1

Plan of all Garrison project areas (Showing Berechurch Dyke) (after CAT)

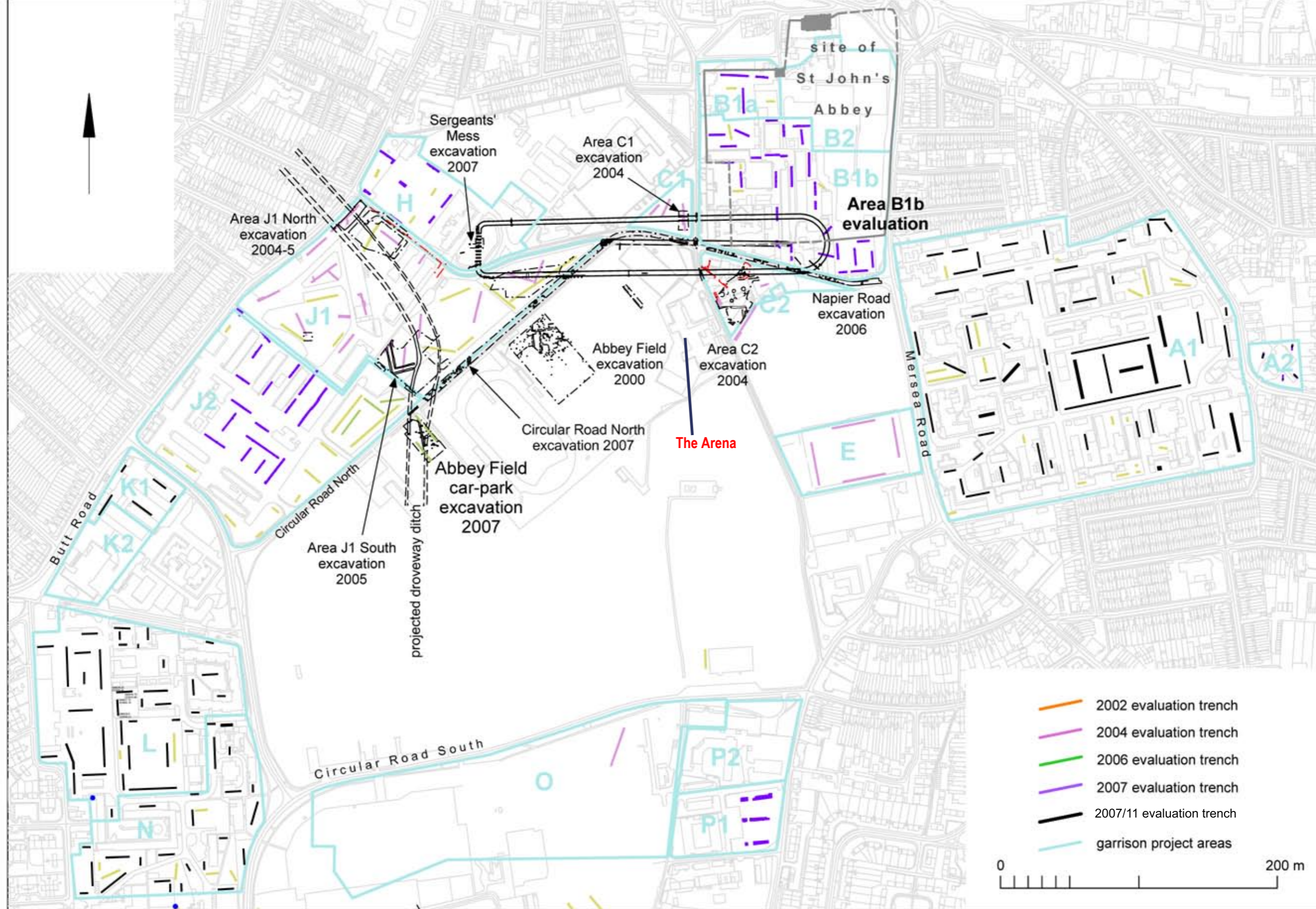
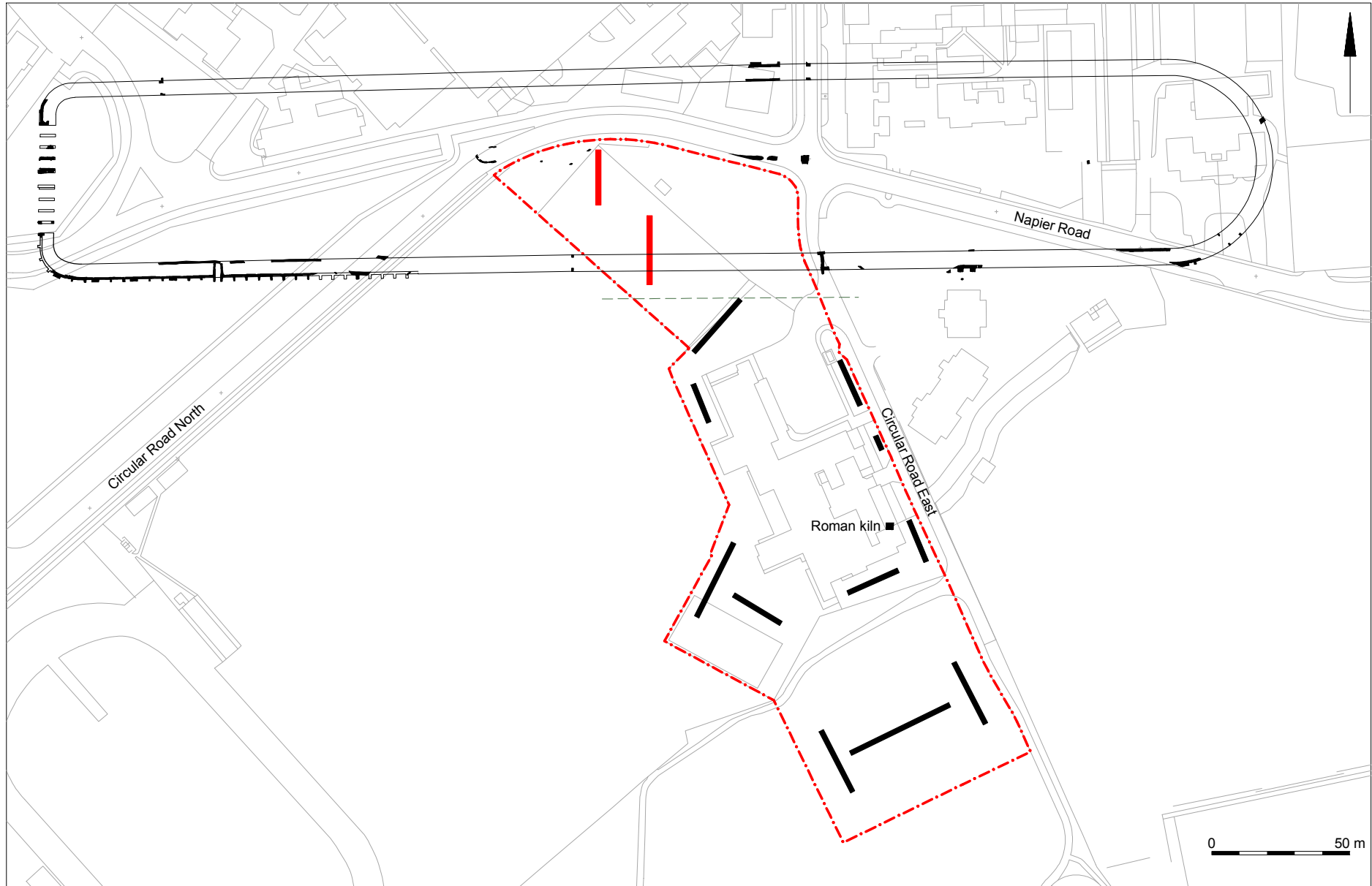



FIGURE 2

Proposed trench layout at Colchester Arena showing Roman Circus



© Crown copyright. All rights reserved. Licence number 100039294.

Fig 2 Proposed trench layout at Colchester Arena: partial extent for Phase 1b trenches – remainder to be determined following Phase 1a trenching and design.

 Phase 1a
  Phase 1b

OASIS DATA COLLECTION FORM: England

[List of Projects](#) | [Manage Projects](#) | [Search Projects](#) | [New project](#) | [Change your details](#) | [HER coverage](#) | [Change country](#) | [Log out](#)

Printable version

OASIS ID: colchest3-210052

Project details

Project name	Evaluation at The Arena, Circular Road East, Colchester
Short description of the project	Evaluation by trial trenching prior to residential and commercial redevelopment. The site contains part of the Roman circus (SM 35614) and Roman burials are expected.
Project dates	Start: 29-04-2015 End: 16-06-2015
Previous/future work	Yes / Yes
Any associated project reference codes	15/02f - Contracting Unit No.
Type of project	Field evaluation
Site status	Scheduled Monument (SM)
Current Land use	Community Service 2 - Leisure and recreational buildings
Current Land use	Industry and Commerce 2 - Offices
Monument type	FIELD BOUNDARY Roman
Monument type	INHUMATION Roman
Monument type	FIELD BOUNDARY Post Medieval
Monument type	PIT Post Medieval
Monument type	TREE THROW None
Monument type	DITCH Uncertain
Monument type	POST HOLE Modern
Monument type	POST HOLE Uncertain
Monument type	PIT Roman
Significant Finds	POT Roman
Significant Finds	TEGULA Roman
Significant Finds	PEG TILE Post Medieval
Significant Finds	ARCHITECTURAL FRAGMENT Roman
Significant Finds	NECK RING Roman
Methods & techniques	"Sample Trenches"
Development type	Urban commercial (e.g. offices, shops, banks, etc.)
Development type	Urban residential (e.g. flats, houses, etc.)

Position in the planning process Pre-application

Project location

Country England
 Site location ESSEX COLCHESTER COLCHESTER The Arena Leisure Centre, Circular Road East, Colchester
 Postcode CO2 7SZ
 Study area 1.90 Hectares
 Site coordinates TL 997 244 51.8818169388 0.901882053155 51 52 54 N 000 54 06 E Point
 Height OD / Depth Min: 32.80m Max: 33.60m

Project creators

Name of Organisation Colchester Archaeological Trust
 Project brief originator CBC Archaeological Officer
 Project design originator Chris Lister
 Project director/manager Chris Lister
 Project supervisor Mark Baister
 Type of sponsor/funding body Developer
 Name of sponsor/funding body RMPA

Project archives

Physical Archive recipient Colchester Museum
 Physical Archive ID 2015.43
 Physical Contents "Animal Bones","Ceramics","other"
 Digital Archive recipient Colchester Museum
 Digital Archive ID 2015.43
 Digital Contents "Animal Bones","Ceramics","Metal"
 Digital Media available "Images raster / digital photography","Survey","Text"
 Paper Archive recipient Colchester Museum
 Paper Archive ID 2015.43
 Paper Contents "Animal Bones","Ceramics","Stratigraphic","Survey"
 Paper Media available "Context sheet","Correspondence","Diary","Drawing","Miscellaneous Material","Notebook - Excavation',' Research',' General Notes","Photograph","Plan","Report","Section","Survey ","Unpublished Text"

Project bibliography

1

Publication type	Grey literature (unpublished document/manuscript)
Title	Archaeological trial trenching at the Arena Leisure Centre, Circular Road East, Colchester, Essex Phase 1a: pre-determination trenching April-May 2015
Author(s)/Editor(s)	Baister, M
Other bibliographic details	CAT Report 843
Date	2015
Issuer or publisher	Colchester Archaeological Trust
Place of issue or publication	Colchester
Description	A4 printout in clear plastic binder.
URL	http://cat.essex.ac.uk/summaries/CAT-0843.html
Entered by	Mark Baister (mb@catuk.org)
Entered on	16 June 2015

OASIS:

Please e-mail Historic England for OASIS help and advice

© ADS 1996-2012 Created by [Jo Gilham](#) and [Jen Mitcham](#), email Last modified Wednesday 9 May 2012

Cite only: <http://www.oasis.ac.uk/form/print.cfm> for this page